

NIPPON THOMPSON CO., LTD. (JAPAN)

Head Office : 19-19, Takanawa 2-chome, Minato-ku,
Tokyo, 108-8586, Japan
Phone : +81 (0)3-3448-5850
Fax : +81 (0)3-3447-7637
E-mail : ntt@ikonet.co.jp
URL : https://www.ikont.co.jp/eg/
Plant : Gifu, Kamakura



IKO INTERNATIONAL, INC. (U.S.A.)

East Coast Operations (Sales Head Office)

91 Walsh Drive,
Parsippany, NJ, 07054,
U.S.A.
Phone : +1-973-402-0254
Toll Free : +1-800-922-0337
Fax : +1-973-402-0441
E-mail : eco@ikonet.co.jp



Midwest Operations

101 Mark Street, Unit-G,
Wood Dale, IL, 60191,
U.S.A.
Phone : +1-630-766-6464
Toll Free : +1-800-323-6694
Fax : +1-630-766-6869
E-mail : mwo@ikonet.co.jp

West Coast Operations

9830 Norwalk Boulevard, Suite 198,
Santa Fe Springs, CA, 90670,
U.S.A.
Phone : +1-562-941-1019
Toll Free : +1-800-252-3665
Fax : +1-562-941-4027
E-mail : wco@ikonet.co.jp

Silicon Valley Sales Office

1500 Wyatt Drive, Suite 10,
Santa Clara, CA, 95054,
U.S.A.
Phone : +1-408-492-0240
Toll Free : +1-800-252-3665
Fax : +1-408-492-0245
E-mail : wco@ikonet.co.jp

Southeast Operations

3235 Satellite Boulevard Building 400, Suite 230,
Duluth, GA, 30096,
U.S.A.
Phone : +1-770-418-1904
Toll Free : +1-800-874-6445
Fax : +1-770-418-9403
E-mail : seo@ikonet.co.jp

Southwest Operations

6191 N STATE HIGHWAY 161, STE 440,
IRVING, TX 75038-2264,
U.S.A.
Phone : +1-972-925-0444
Toll Free : +1-800-295-7886
Fax : +1-972-707-0385
E-mail : swo@ikonet.co.jp

IKO THOMPSON BEARINGS CANADA, INC.(CANADA)

731-2425, Matheson Boulevard East, 7th floor,
Mississauga, Ontario, L4W 5K4, Canada
Phone : +1-905-361-2872
Fax : +1-905-361-6401
E-mail : itc@ikonet.co.jp

IKO BRASIL SERVIÇOS EMPRESARIAIS EIRELI (BRAZIL)

Rua Frei Caneca 1407,
Condominio Edificio Barão de Monte Cedro,
Cjs. 801/802, Consolação, São Paulo- SP
Cep: 01307-909
Phone : +55 (0)11-2366-3033
E-mail : itb@ikonet.co.jp

NIPPON THOMPSON EUROPE B.V. (EUROPE)

The Netherlands (Sales Head Office)

Keersopstraat 35,
3044 EX, Rotterdam,
The Netherlands
Phone : +31 (0)10-462 68 68
E-mail : nte@ikonet.co.jp



Germany Branch

Mündelheimer Weg 54,
40472 Düsseldorf,
Germany
Phone : +49 (0)211-41 40 61
Fax : +49 (0)211-42 76 93
E-mail : ntd@ikonet.co.jp

Regensburg Sales Office

Im Gewerbepark D 30,
93059 Regensburg,
Germany
Phone : +49 (0)941-20 60 70
Fax : +49 (0)941-20 60 719
E-mail : ntdr@iko-nt.de

U.K. Branch

2 Vincent Avenue, Crownhill,
Milton Keynes, Bucks, MK8 0AB,
United Kingdom
Phone : +44 (0)1908-566144
E-mail : sales@iko.co.uk

Spain Branch

Autovia Madrid-Barcelona, Km. 43,700
Polig. Ind. AIDA - Nove A-8, Ofic. 2-1^a
19200-Azuqueca de Henares,
(Guadalajara) Spain
Phone : +34 949-26 33 90
Fax : +34 949-26 31 13
E-mail : nts@ikonet.co.jp

France Branch

Bâtiment le Raphaël-Paris, Nord 2,
22 avenue des Nations
BP54394 Villepinte
95943 ROISSY C.D.G Cedex
France
Phone : +33 (0)1-48 16 57 39
Fax : +33 (0)1-48 16 57 46
E-mail : ntf@ikont.eu

IKO THOMPSON ASIA CO., LTD. (THAILAND)

1-7 Zuellig House, 3rd Floor,
Silom Road, Silom, Bangrak,
Bangkok 10500, Thailand
Phone : +66 (0)2-637-5115
Fax : +66 (0)2-637-5116
E-mail : ita@ikonet.co.jp

IKO THOMPSON KOREA CO.,LTD. (KOREA)

201, Worldvision Bldg., 77-1, Yeouinaru-ro,
Yeongdeungpo-gu, Seoul, Korea
Phone : +82 (0)2-6337-5851
Fax : +82 (0)2-6337-5852
E-mail : itk@ikonet.co.jp

IKO-THOMPSON (SHANGHAI) LTD. (CHINA)

Shanghai (Sales Head Office)

2301, MetroPlaza No.555, LouShanGuan
Road, ChangNing District, Shanghai,
People's Republic of China, 200051
Phone : +86 (0)21-3250-5525
Fax : +86 (0)21-3250-5526
E-mail : ntc@ikonet.co.jp

Beijing Branch

Room 1909, Tower C Oriental Media Center,
Guanghua Road No. 4 Chaoyang District, Beijing,
People's Republic of China, 100026
Phone : +86 (0)10-6515-7681
Fax : +86 (0)10-6515-7689
E-mail : ntc@ikonet.co.jp

Guangzhou Branch

Room 834, Garden Tower, Garden Hotel
368 Huanshi East Road, Yuexiu District, Guangzhou,
Guangdong
People's Republic of China, 510064
Phone : +86 (0)20-8384-0797
Fax : +86 (0)20-8381-2863
E-mail : ntc@ikonet.co.jp

Wuhan Branch

Room 2300, Truroll Plaza No.72, Wusheng Road,
Qiao kou District, Wuhan, Hubei,
People's Republic of China, 430033
Phone : +86 (0)27-8556-1610
Fax : +86 (0)27-8556-1630
E-mail : ntc@ikonet.co.jp

Shenzhen Branch

Room1808, KEENSTAR Building 18,
Chuangye 2nd Rd 248, Bao'an, Shenzhen, Guangdong,
People's Republic of China, 518081
Phone : +86 (0)755-2265-0553
Fax : +86 (0)755-2298-0665
E-mail : ntc@ikonet.co.jp

Xian Branch

Room 2010, Block B, Chaoyang International Plaza,
No. 166,
Changle West Road, Xincheng District Xi'an, Shanxi,
People's Republic of China, 710032
Phone : +86 (0)29-8323-5915
Fax : +86 (0)29-8323-5915
E-mail : ntc@ikonet.co.jp

Qingdao Branch

Room 608, Building 47, Huarun City,
No. 101 Shenzhen Road, Laoshan District,
Qingdao City, Shandong
People's Republic of China, 266100
전화 : +86 (0)532-8670-2246
팩스 : +86 (0)532-8670-2242
E-mail : ntc@ikonet.co.jp

Ningbo Office

Room 3406, Zhongnongxin Building, No.181,
Zhongshan East Road, Haishu Ward, Ningbo,
Zhejiang
People's Republic of China, 315000
Phone : +86 (0)574-8718-9535
Fax : +86 (0)574-8718-9533
E-mail : ntc@ikonet.co.jp

Shenyang Office

2-1203 Tower I, City Plaza Shenyang NO.206,
Nanjing North Street, Heping District, Shenyang,
People's Republic of China, 110001
Phone : +86 (0)24-2334-2662
Fax : +86 (0)24-2334-2442
E-mail : ntc@ikonet.co.jp

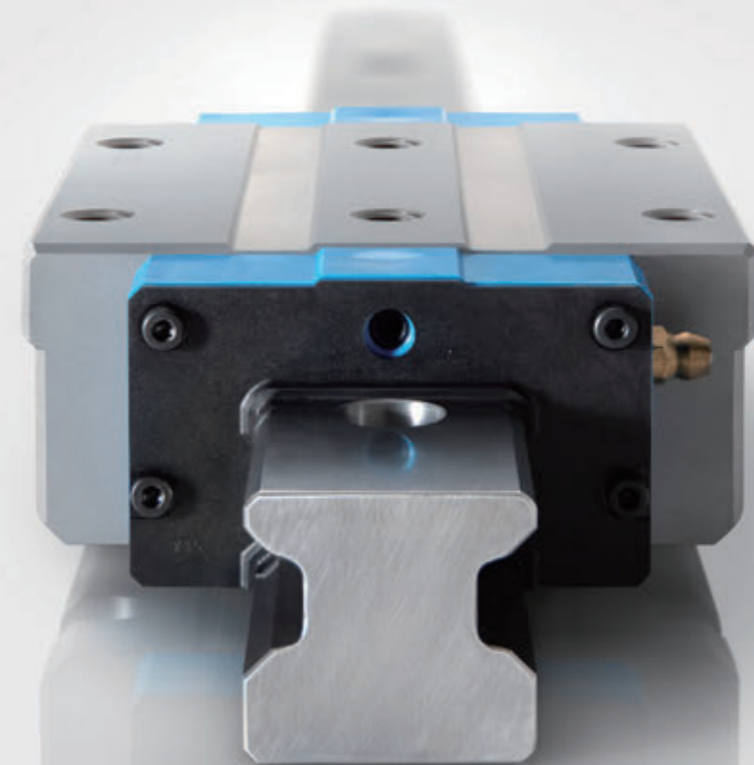

Linear Roller Way Super X

Linear Roller Way Super X

The History of the IKO Linear Roller Way

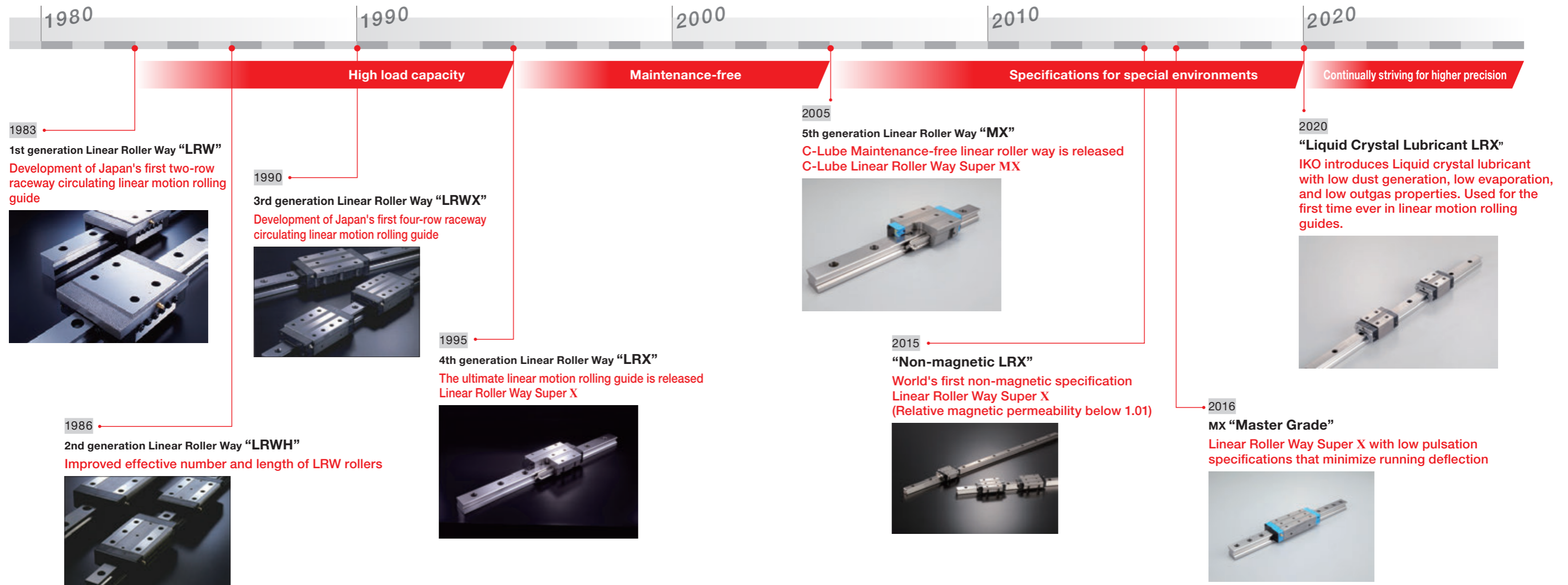

Advanced technological developments lead the way in supporting Japanese manufacturing

In 1956, IKO was the first company in Japan to commercialize needle roller bearings, which mainly support rotational motion in automobiles, motorcycles, and industrial robots.

To apply the know-how gained through the development of needle roller bearings to machine tools, the so-called "mother of industry," IKO began full-scale research and development of Linear Ways, a type of linear motion rolling guide.

In 1978, the company developed a ball-type linear way, and in 1983 succeeded in developing the world's first linear roller way that used rollers instead of balls as rolling elements.

This provided significantly higher load capacity and longer service life than the ball type, and introduced new possibilities for linear motion rolling guides.

In the 1990s, the company succeeded in developing the Super X, which took linear roller way performance to the next level.

Through the development and supply of such high performance, and high-value-added linear motion rolling guides, IKO has contributed to improving the performance of machine tools and the precision of the products manufactured by them, which strongly supports Japan's position as a manufacturing powerhouse.

IKO offers the added value of Maintenance-free to meet customer demand

In the early 2000s, when products from other manufacturers were finally available to the market, IKO was already aiming for the next level and developing products to solve linear way problems from a different perspective.

A major inconvenience to customers at the time was the maintenance work required to regularly lubricate the linear ways. IKO released the maintenance-free C-Lube series in 2002, which eliminated the need to perform routine lubrication maintenance.

Since then, the series has been expanded to IKO's mainstay products, contributing not only to reducing labor hours and the inconvenience associated with routine maintenance, but

also adding value through reducing the environmental impact since less lubrication oil is used overall.

We are very proud to be a company committed to "Advanced Technological Development" as evidenced by our introduction of the world's first liquid crystal lubricated linear roller way in 2020 which utilizes liquid crystal lubricant, a new lubricant with non-evaporating properties, in place of lubrication oil.

We will continue to work closely with our customers to help solve their problems while pushing ahead on the path to even higher linear way performance. This commitment will never change.



Linear Roller Ways are the optimal solution for the growing demands on machine tools

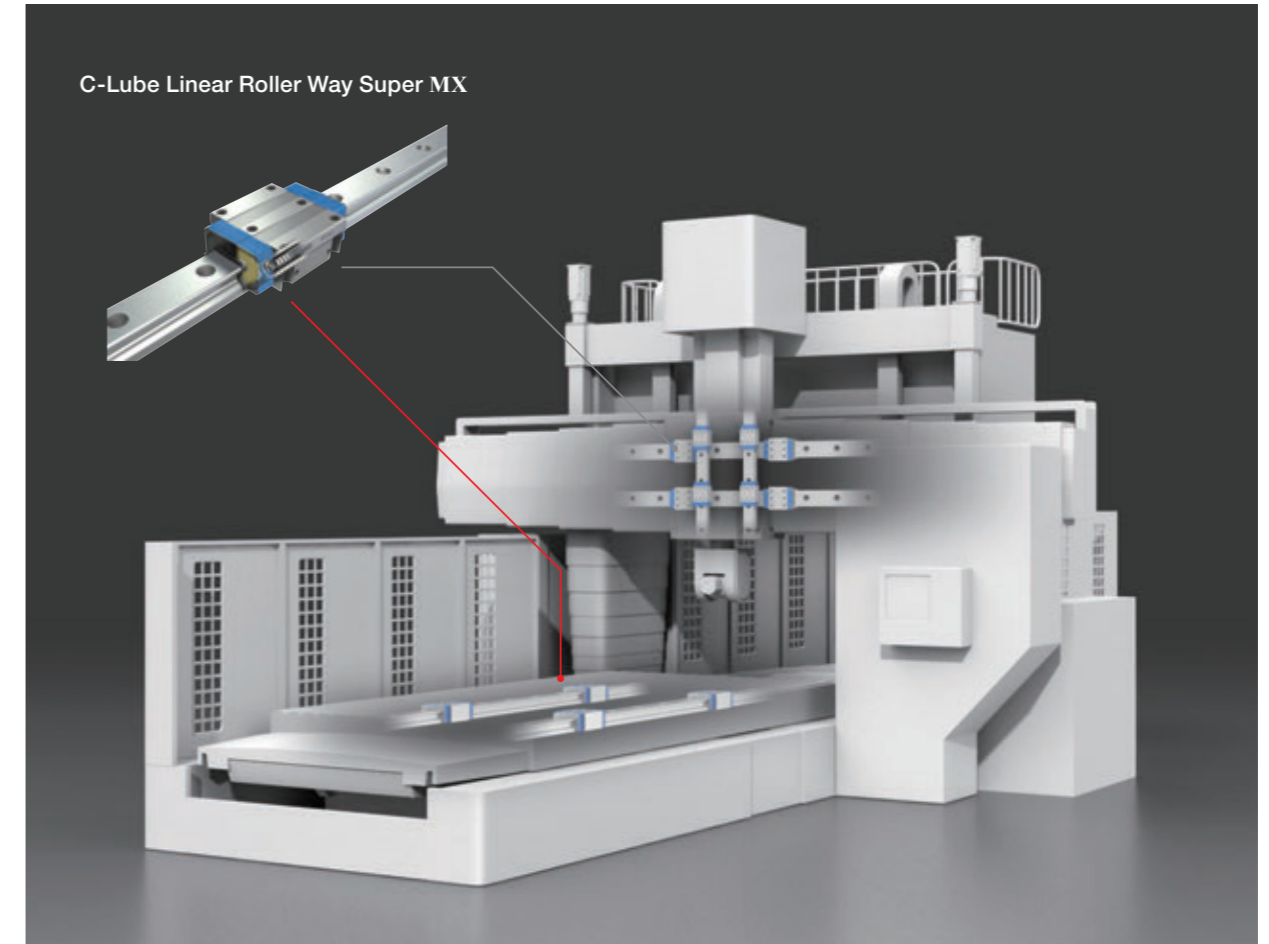

Advancing the sophistication of all industries

In the past, linear motion guides for machine tools generally used a sliding guide system in which lubrication oil was applied between the stationary part and the motion part in order to achieve high-precision motion while withstanding high loads.

Later, linear motion rolling guides, such as the IKO Linear Way, were released with performance as good as that of a sliding guide, and these linear motion rolling guides soon became popular for machine tools.

This was due to a number of factors, including the improved performance of linear motion rolling guides that use a rolling guide system, as well as the need for downsized machine tools and simplified assembly work. In recent years, greater accuracy has been demanded

for automotive parts, electronic parts, and precision parts, and linear motion rolling guides, which determine the accuracy of various machine tools, are required to have higher rigidity, higher precision, and higher speed. IKO Linear Roller Ways were developed in response to these demands. Linear Roller Ways, which use rollers instead of balls for the rolling elements inside the product, have advantages over ball-type rolling elements in terms of load capacity, rigidity, damping, accuracy, friction, life, and acoustics, and are increasingly used in all industrial fields where these characteristics are required.



IKO Linear Roller Way Super X

The ultimate linear motion rolling guide

Super X
offers
7
advantages

- | | |
|---|---|
| <p>1 Increased load rating
due to improved loading zone
contact area</p> | <p>High load capacity is achieved by contact with the wire. Contributes to greater compactness, lighter weight and long life.</p> |
| <p>2 Improved machining accuracy
through increased rigidity of
rolling elements</p> | <p>Reduced displacement of metalworking equipment due to increased rigidity maintains long-term high machining accuracy.</p> |
| <p>3 Improved vibration damping
Improves machining
quality</p> | <p>Provides precise and beautifully machined surfaces by minimizing vibration during workpiece machining.</p> |
| <p>4 Low friction coefficient improves
tracking performance</p> | <p>Contributes to reduced load on drive components, stable running, and energy savings as less force is required to move.</p> |
| <p>5 Less wear from traveling
Stable accuracy</p> | <p>Wear is reduced due to line contact rather than point contact. Contributes to increased stability of dimensional accuracy.</p> |
| <p>6 Reduces minute
pulsations
while rollers are running</p> | <p>Special machining of the running surface reduces microvibrations to the utmost limit. Improves surface finish accuracy.</p> |
| <p>7 Reduces strain on
operators
by reducing noise</p> | <p>Optimizing the roller circulation structure suppresses high frequency range resulting in low noise.</p> |

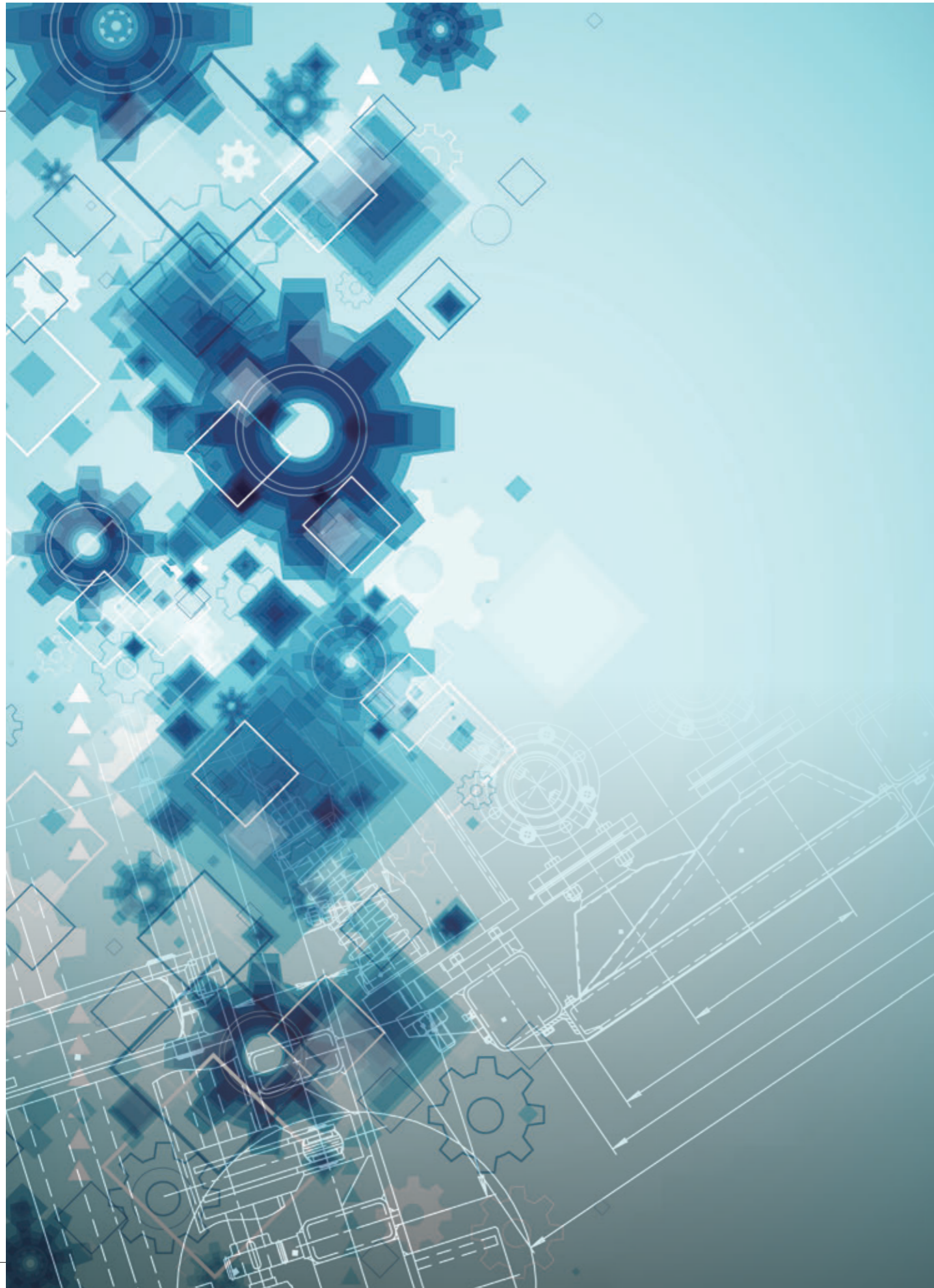

What makes the difference is the optimized circulatory structure.

The IKO Linear Roller Way Super X is an endless-motion linear rolling guide with four rows of cylindrical rollers balanced in a rigid casing.

The same guiding method is also used in general roller bearings, however IKO's unique know-how is concentrated in the guiding parts to provide smoother circulation of the cylindrical rollers.

The two pairs of V-shaped raceway surfaces on the left and right sides are arranged at a 45-degree contact angle to support loads and moments from the top, bottom, left and right sides.

Maintenance-free, low-pulsation, dust-proof, and liquid crystal lubrication specifications are also available.

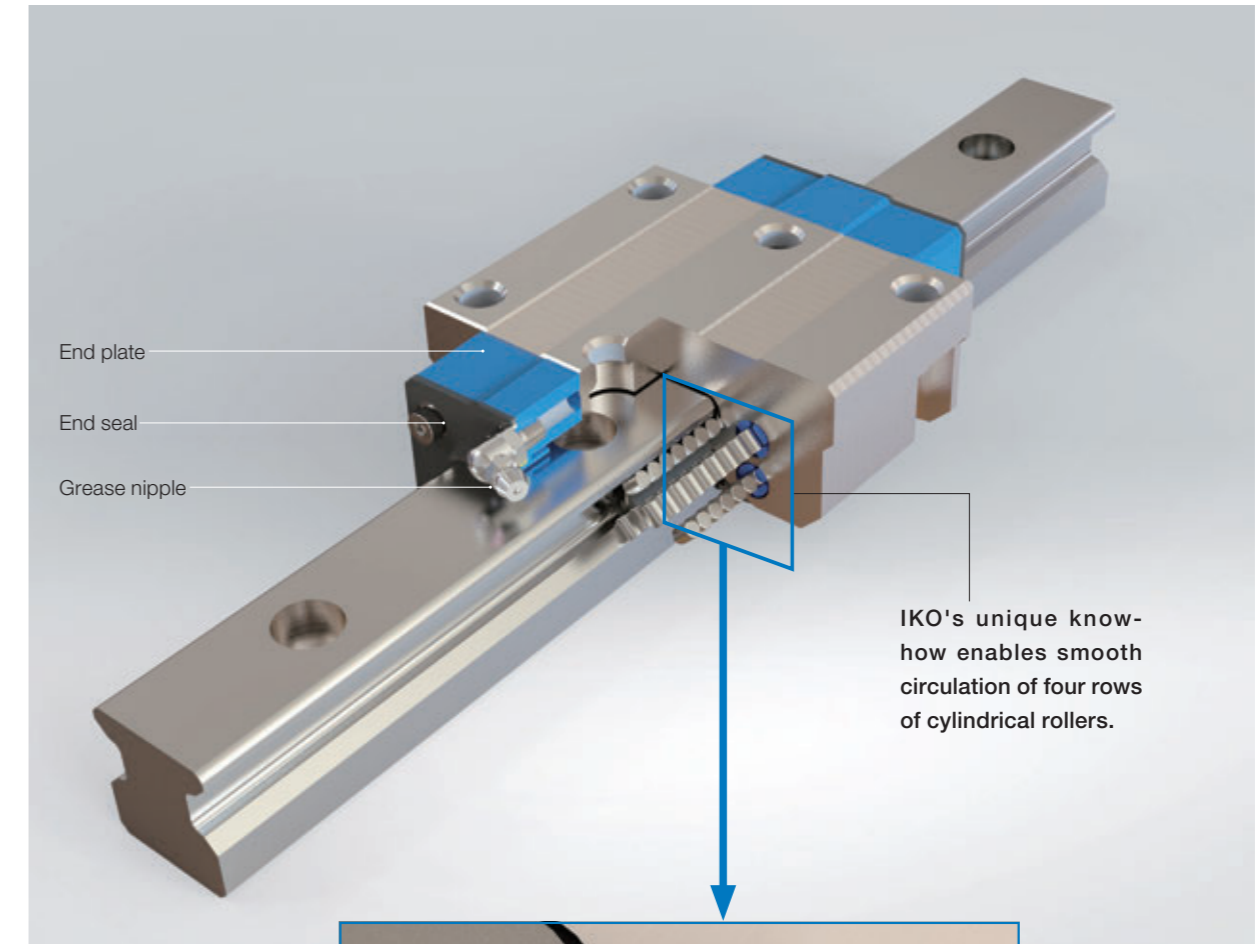



Roller Type vs. Ball Type Performance Comparison 1

Super high load capacity

Graphs below show comparison between "Basic dynamic load rating" and "Basic static load rating" of roller type (MX, LRX) and ball type (MH, LWH). The number of cylindrical rollers and large contact area of the roller type provides excellent load capacity, which allows for a larger load rating.

One size smaller than ball type can be used

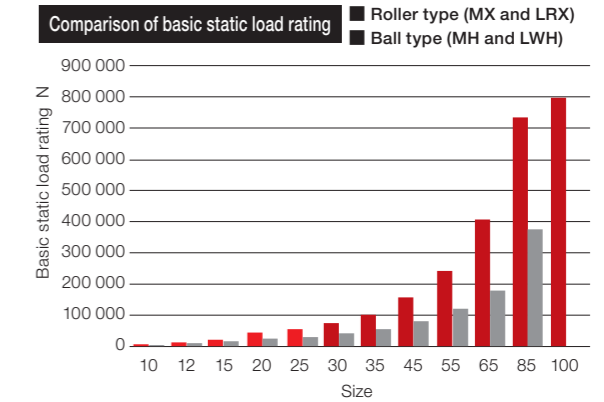
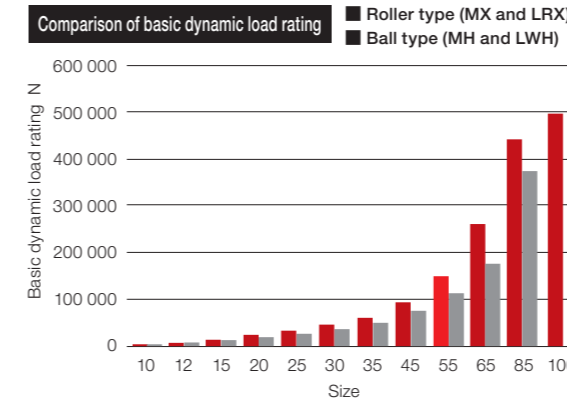

Long life

Comparison of roller type (MXG45) and ball type (MHG45) load rating values. When the applied load is 10,000 N, the calculated life is more than five times longer than that of the ball type, providing a significant difference.

Roller type has large basic dynamic load rating C, and long life due to the different index

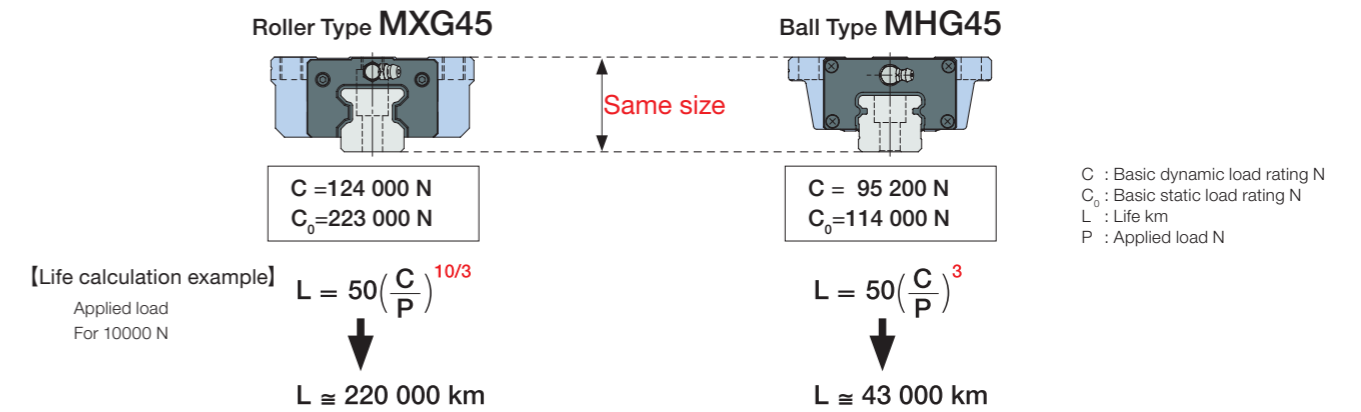

Super high rigidity

The graph below shows comparison between elastic deformation characteristics of roller type (MX25) and ball type (MH25). The roller type achieves high rigidity as a number of small cylindrical rollers with smaller elastic deformation relative to load than that of balls are incorporated in the slide unit.

Well-balanced high rigidity is achieved in every direction

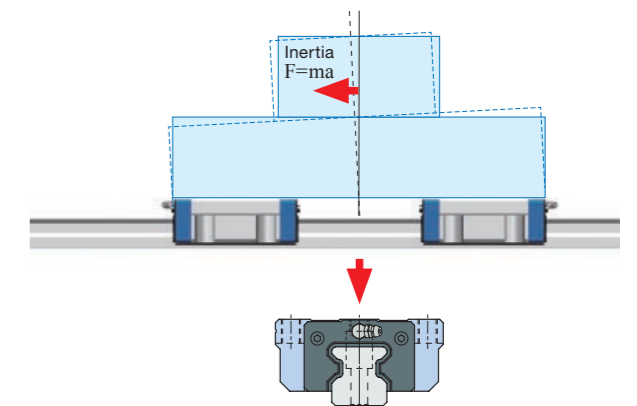
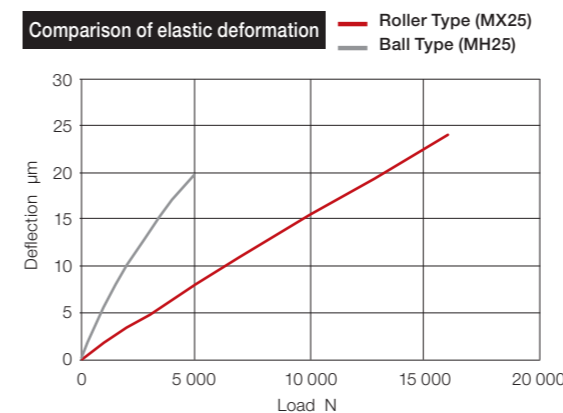

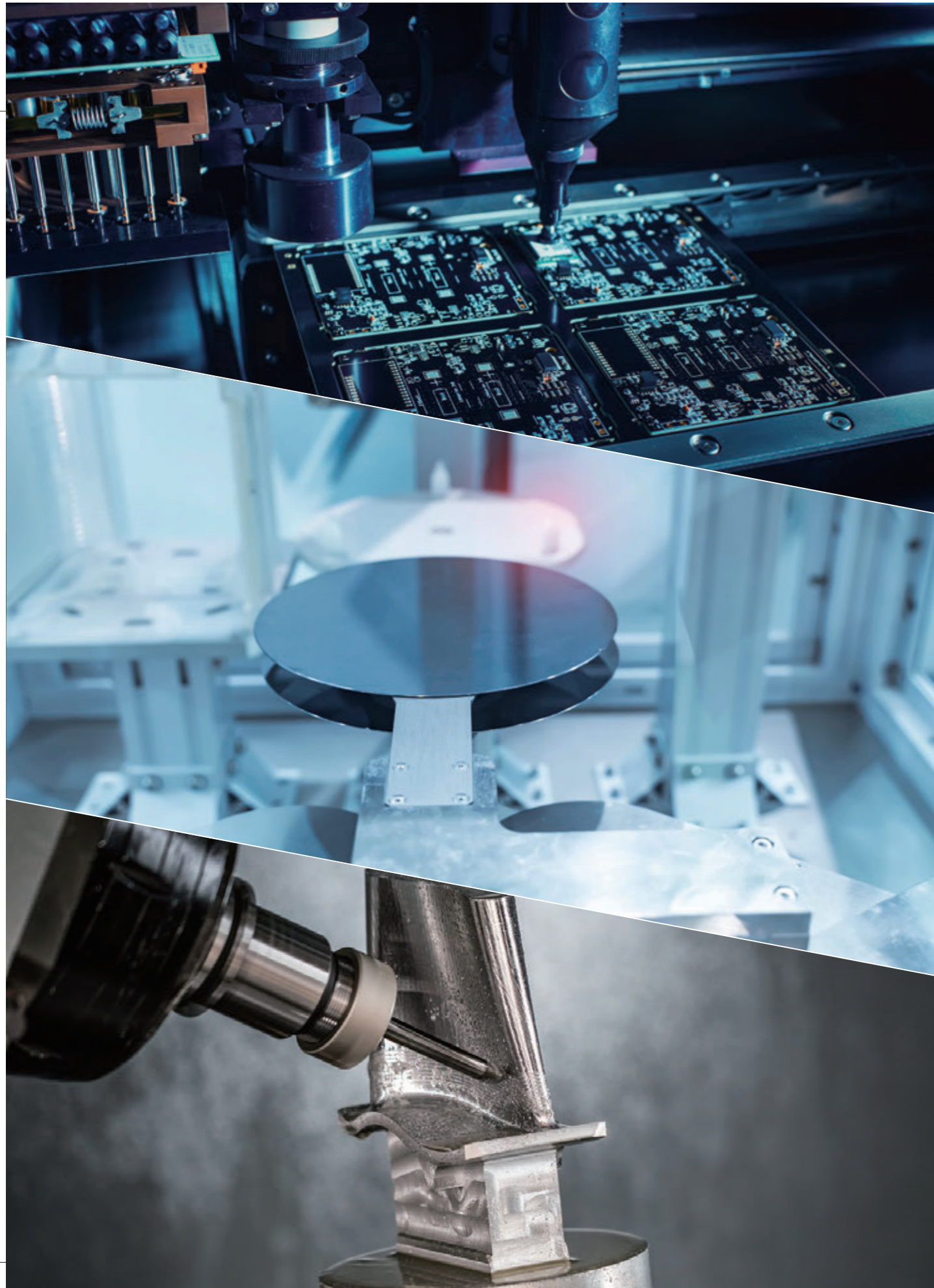

Roller Type vs. Ball Type Performance Comparison 2

Excellent vibration characteristics

Comparison of vibration damping curves (half amplitude) of the same size roller type (MX15) and ball type (MH15) during downward vibration. As the rigidity is higher with the roller type, deformation amount is low relative to repeated fluctuating load, natural frequency is high and vibration damping time is short.

Reduced positioning time speeds up machine and equipment operation

Vibration damping curve in downward vibration (Half amplitude)

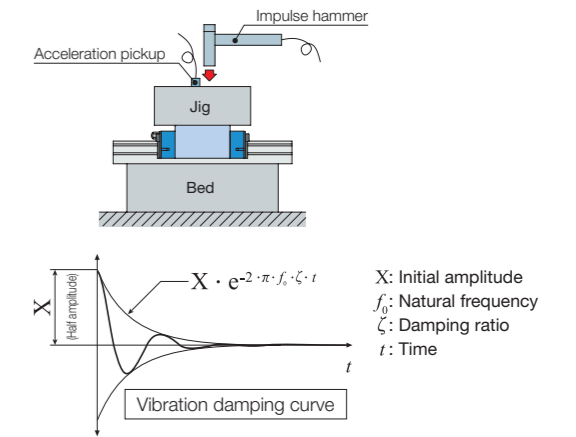
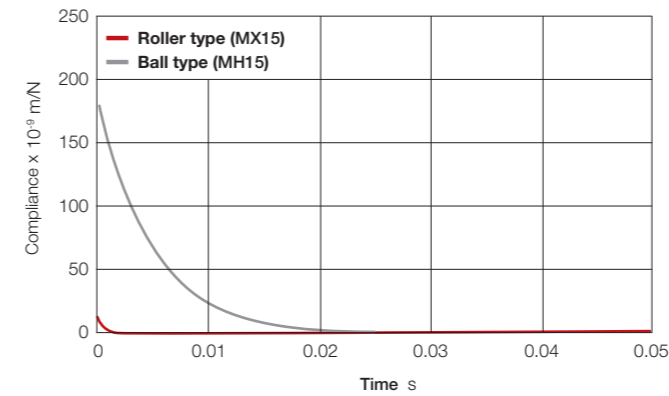

Excellent frictional characteristics

The roller type prevents skew of cylindrical rollers and achieves smooth motion by adopting a unique retaining system to accurately guide cylindrical roller ends with retaining plate. It also has good response characteristics to micro-feeding and allows for accurate positioning, thanks to low frictional resistance against preload and load, with excellent frictional characteristics relative to sliding guides and ball type linear motion rolling guides.

Cylindrical rollers with low frictional resistance ensure excellent following capability even for micro-feeding

MXDL25 and MXDG45 T₃ preload frictional resistance

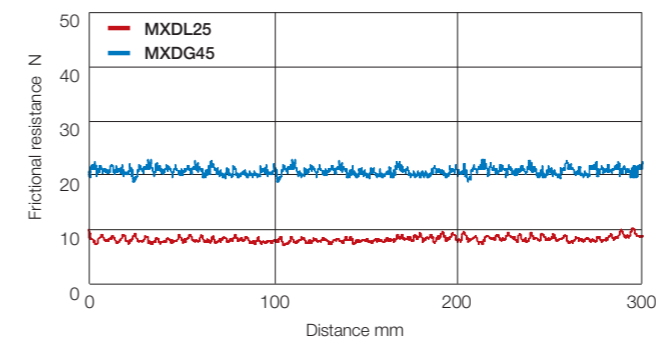

Test portion	Extra long unit MXDL25 Long unit MXDG45
Preload	T ₃ preload
Speed	0.6 m/min
Lubrication	C-Lube integrated, with grease

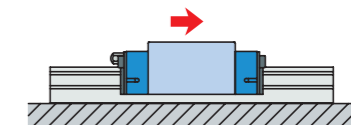

High running accuracy

Optimal design based on analysis of re-circulation behavior of cylindrical roller circulation realizes smooth and quiet motion. In addition, load is applied to many cylindrical rollers, minimizing micro deflections during running. Extra long unit is optimal for applications requiring higher running accuracy.

Achieves stable running accuracy by minimizing even the smallest runout

Deflection amount during running

MXDG30r3 preload	0.12 (unit: μm)
------------------	-----------------

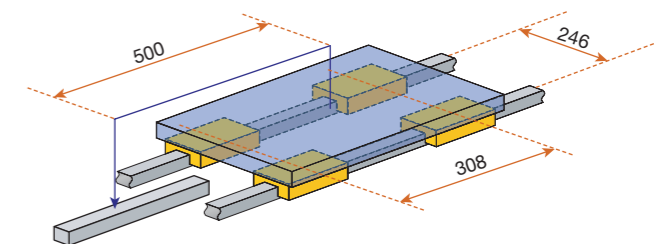

A video showing the various characteristics of the Linear Roller Way Super X is available on the IKO website.
<https://www.ikont.co.jp/eg/product/movie/index.html#03>

The ultimate Linear Roller Way

C-Lube Linear Roller Way Super MX
MX (Master Grade)
 "MASTER GRADE"

For the customers who demand an even higher level of quality and machining accuracy, this is the ultimate in linear roller ways, combining IKO's technology and know-how to achieve the ultimate in low-fluctuation performance.

The C-Lube Linear Roller Way Super MX low fluctuation specification MX "Master Grade" has special precision processing on the roller raceway surface, significantly reducing fluctuation compared to standard extra long units.

Ideal for ultra-precision working machine shaft guides, which require high-precision, high-quality machining.

Features

- 1 Special raceway processing **suppresses minuscule running deflection** and **significantly reduces pulsation** compared to standard extra long units.
- 2 Low fluctuation makes it **ideal for ultra-precision working machine shaft guides**, which require high-precision, high-quality machining.
- 3 The extra long unit contributes to **improved load capacity** and **rigidity** in mechanical equipment.

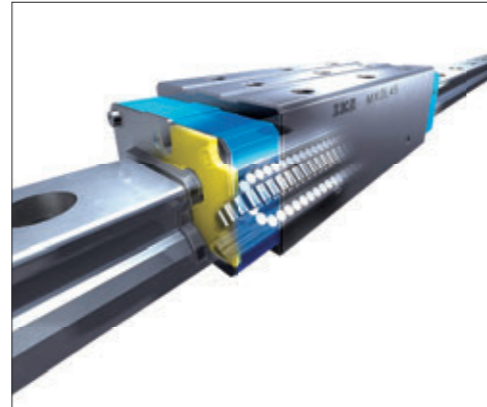

Applicable products

Series	C-Lube Linear Roller Way Super MX	MX Master Grade (low pulsation specifications) is a special order product; if needed please contact IKO.
Supported models	MXL, MXDL, MXSL, MXNL, MXNSL	
Size	20/25/30/35/45/55	

Pulsation comparison data

Pulsation: Refers to the running deflection related to movement of the rolling elements within the Linear Roller Way.

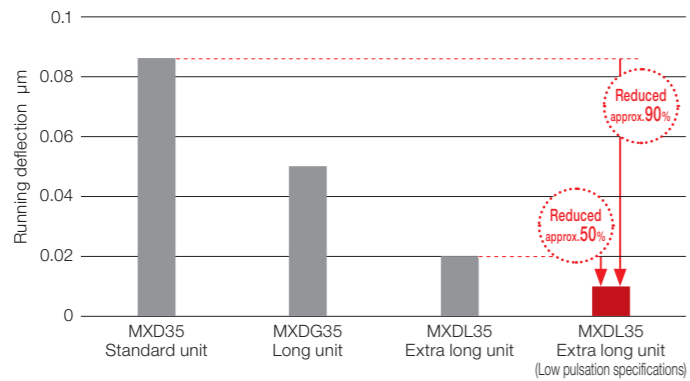

[Measuring method]
 Measures the vertical runout when the table is moved.

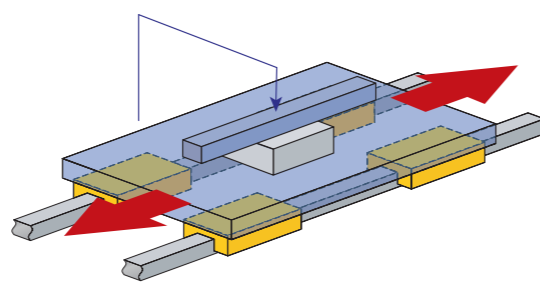

Top-class low pulsation: about 50% less compared with the standard extra long units.

Pulsation data

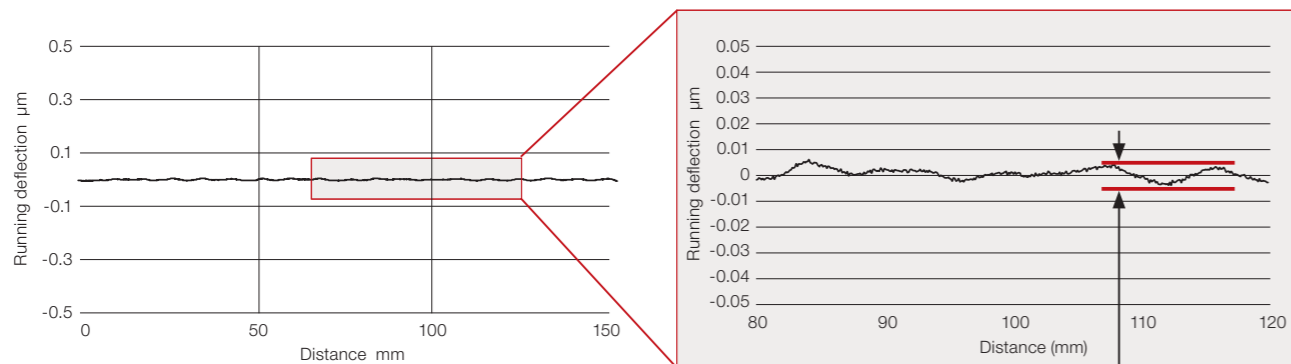

The running deflection value is within **0.0090 µm (9.0 nm)** in actual measurements.

The peak of low pulsation: Zero running deflection

Next-generation
 Linear Roller Way Super X
ZERO

Even with the achievement of the MX Master Grade, IKO did not stop developing advanced products.

The goal is to achieve "zero running deflection" which is the peak result of low pulsation.

IKO is accelerating the development and availability of the ultimate next-generation linear guide, the Linear Roller Way Super X ZERO. Super X ZERO has all the benefits of the LRX, like high load capacity and high rigidity, with the added advantage of near-zero running deflection.



Running deflection comparison data

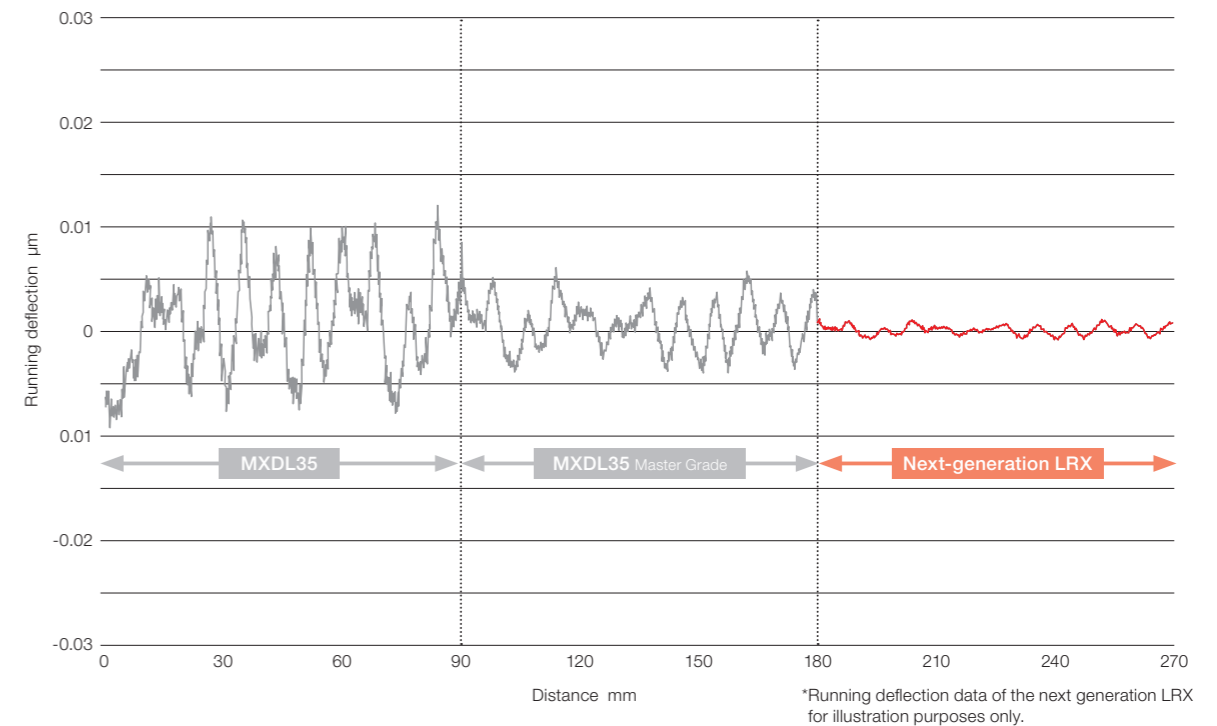

*Running deflection data of the next generation LRX for illustration purposes only.

The high load capacity and high rigidity of LRX are retained, while running deflection (pulsation) and running parallelism are as close as possible to zero.

Smooth movement and maintenance-free: The optimal choice for sustainability compliance

The Linear Roller Way Super MX, which enables smooth operation in machinery and equipment, is a machine component that contributes to reducing environmental impact. In addition, the incorporation of IKO's unique maintenance free C-Lube feature achieves "oil minimum," minimizing the amount of lubrication oil used.

C-Lube Linear Roller Way

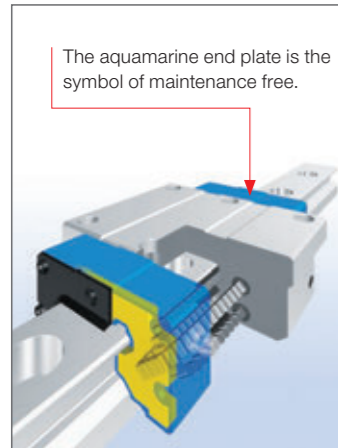

C-Lube integrated

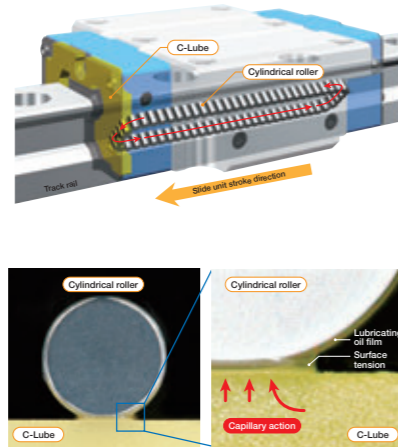

The lubrication oil is supplied directly to the rolling elements, not to the track rail. When rolling elements make contact with the capillary lubricating element integrated with the circulation path of slide unit rolling elements, the lubrication oil is supplied to surfaces of rolling elements and carried to the loading zone through circulation of rolling elements. This results in adequate lubrication oil being properly maintained in the loading area and lubrication performance will last for a long time.

The surface of capillary lubricating element is always covered with the lubrication oil. Lubrication oil is continuously supplied to the surface of rolling elements by surface tension in the contact of capillary lubricating element surface and rolling elements. On the surface of the capillary lubricating element with which the rolling elements make contact, new lubrication oil is always supplied from the other sections.



Maintenance free

Withstands running over 20,000 km without oil lubrication, using the C-Lube lubrication oil alone. Furthermore, grease is prepacked in the slide unit, for long term maintenance free use.

Contributes to extending the life of machinery and equipment¹⁾

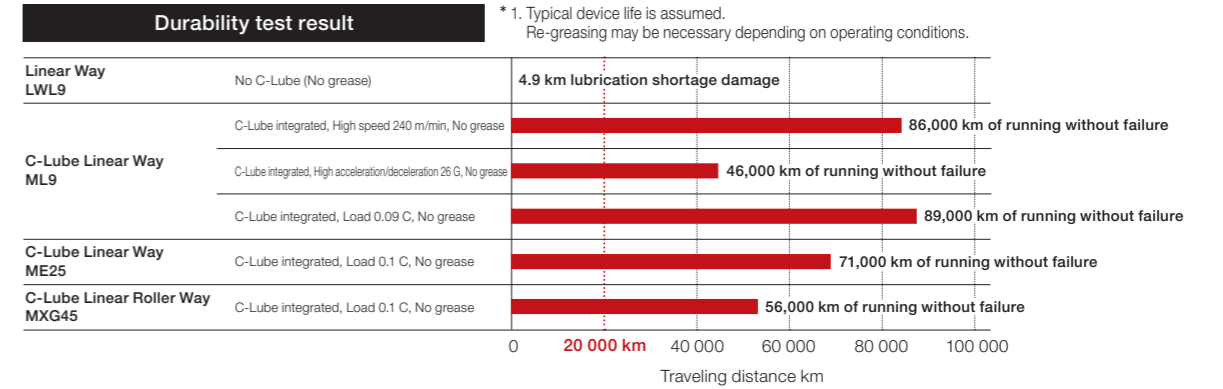

Eco-friendly

C-Lube lubrication oil is supplied only in the amount necessary to maintain the lubrication performance of the rolling guides. Reduces consumption of lubrication oil and maintains lubrication performance even when running for long periods.

Eco-friendly specification reducing usage of lubrication oil

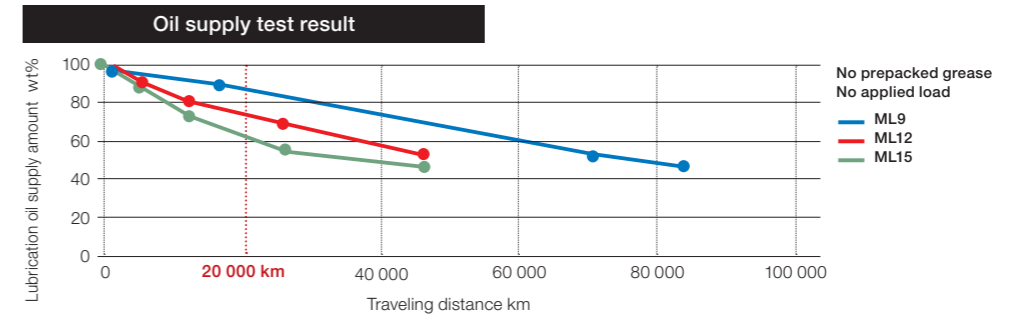

Compact

The C-Lube lubrication part is built in, not external, so that the slide unit is not lengthened. Replacement of conventional parts is also easy, free from constraints of mounting space and stroke length.

Compact design taking into account space-saving

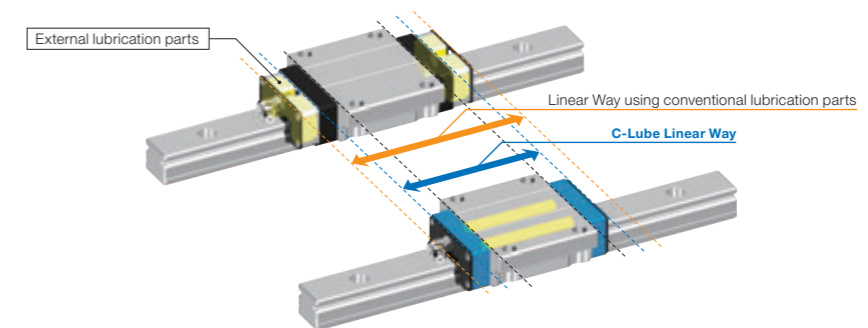

Smooth

Unlike the type of lubrication parts that contact the track rail, the C-Lube does not create sliding resistance. Driving force follow-up characteristics are superior, with energy saved through improvement in accuracy and reduction of friction loss.

Contributes to energy savings through light and smooth operation

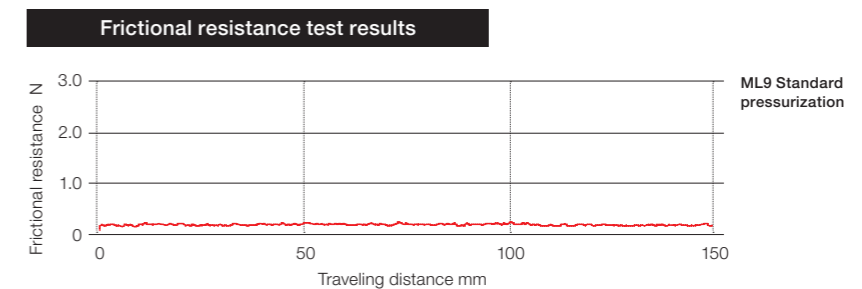

World's first product using liquid crystal lubricant

Liquid Crystal Lubricant Series Linear Roller Ways

IKO has introduced the world's first Linear Roller Ways that are pre-packed with a new liquid crystal lubricant developed by IKO. It utilizes liquid crystals, which are used in LCD TVs and other products, as the lubricant in the linear motion rolling guides. Liquid crystal lubricants are completely different from greases composed of base oils and thickeners. They are composed only of liquid crystal compounds, forming a completely new type of lubricant. Conventional grease base oils lubricate using dissimilar molecules, causing difficulties with adhesion to metal surfaces and evaporation. Liquid crystal lubricant forms molecular aggregates, improving adhesion to metal surfaces and minimizing evaporation. The Liquid Crystal Lubricant Series Linear Roller Way provides excellent lubrication functionality, even under high contact pressure during rolling contact, which results in extremely high performance.

Liquid crystal lubricant structure

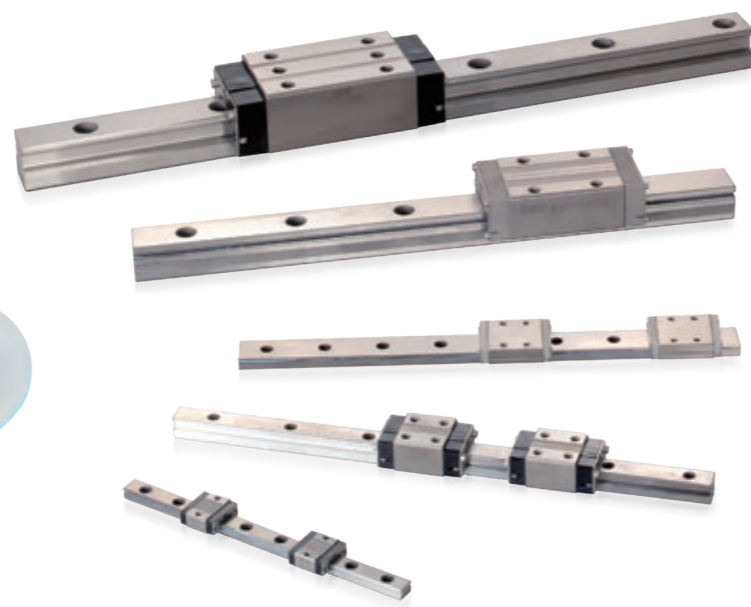
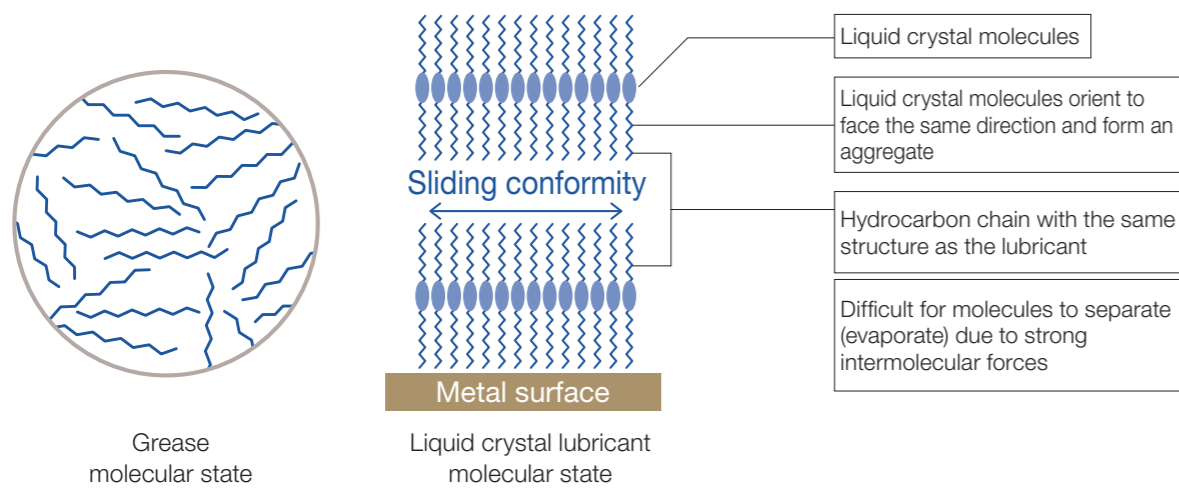

Liquid Crystal Lubricated Linear Roller Ways are individually made to order. Please contact IKO for more information.

Load durability

Long-term durability exceeds 40 times that of fluorine grease at room temperature and at atmospheric pressure. 2 to 6 times greater durability than other types of grease, even in high-temperature environments.

Long-term load durability exceeds 40 times that of fluorine grease at room temperature

Load durability (room temperature)

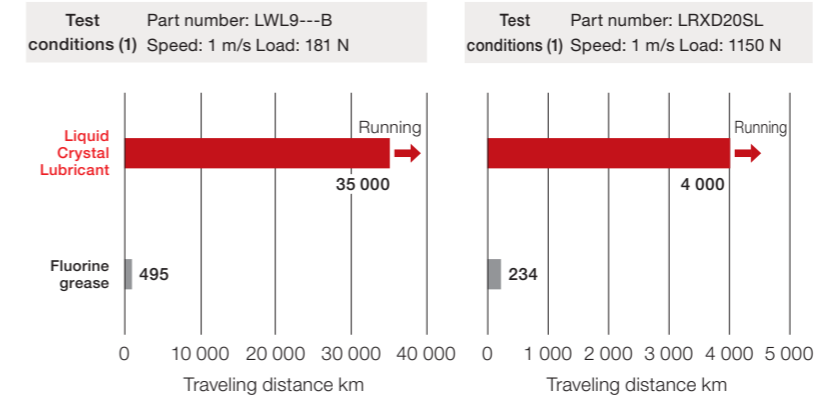

Load durability (high temperature)

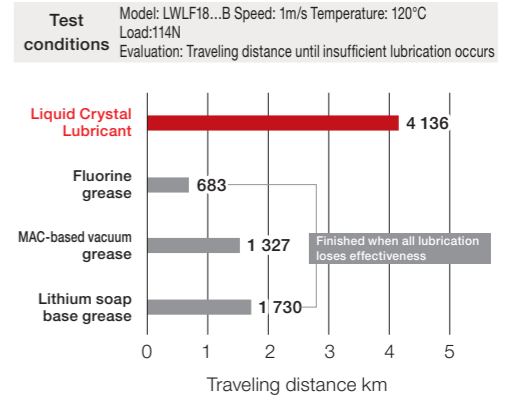

Dust generation / outgas properties

Dust generation is less than 1/10 of that of lithium soap based grease. In addition, outgas properties in high vacuum environments show excellent performance even at high temperatures.

Low dust-generation and outgas properties suitable for clean environments

Low dust-generation properties

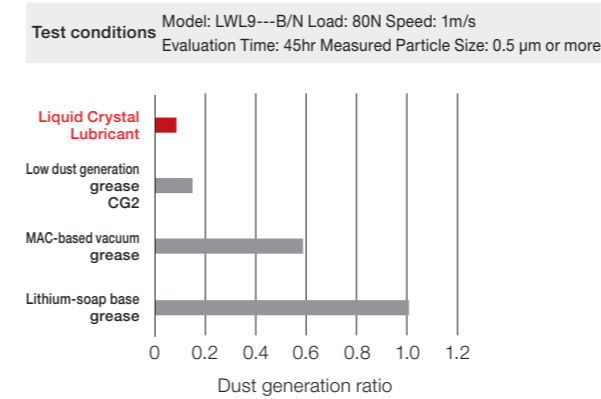

Outgas properties

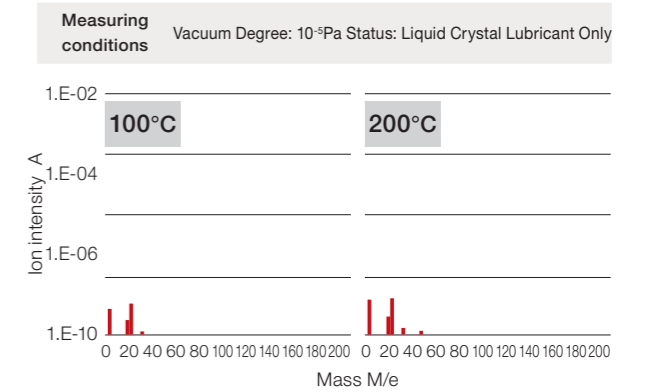

Rolling/ Evaporation characteristics

The rolling resistance is lower than that of fluorinated grease or lithium soap based grease. Even under a high temperature of 100°C, Liquid Crystal Lubricants have no loss due to evaporation.

Lubricant does not evaporate, maintaining smoother operation for a longer period of time

Rolling resistance

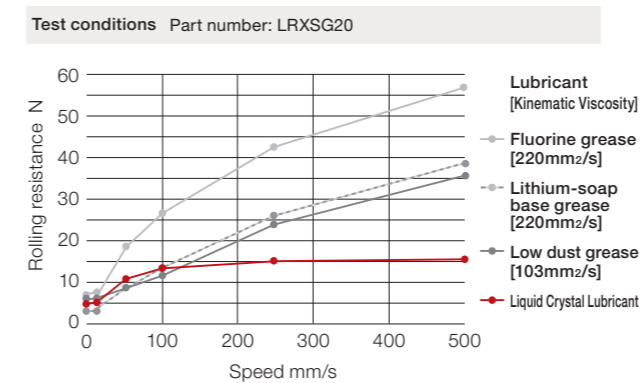

Evaporation characteristics

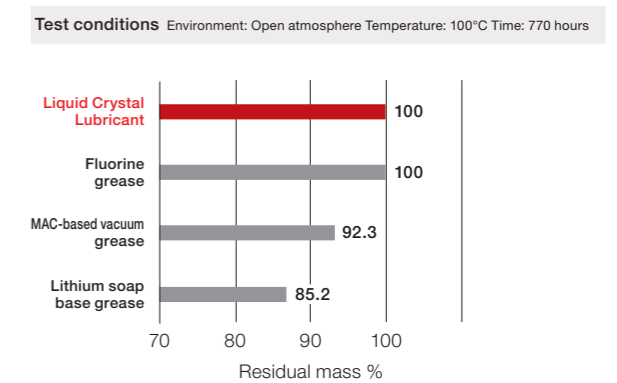

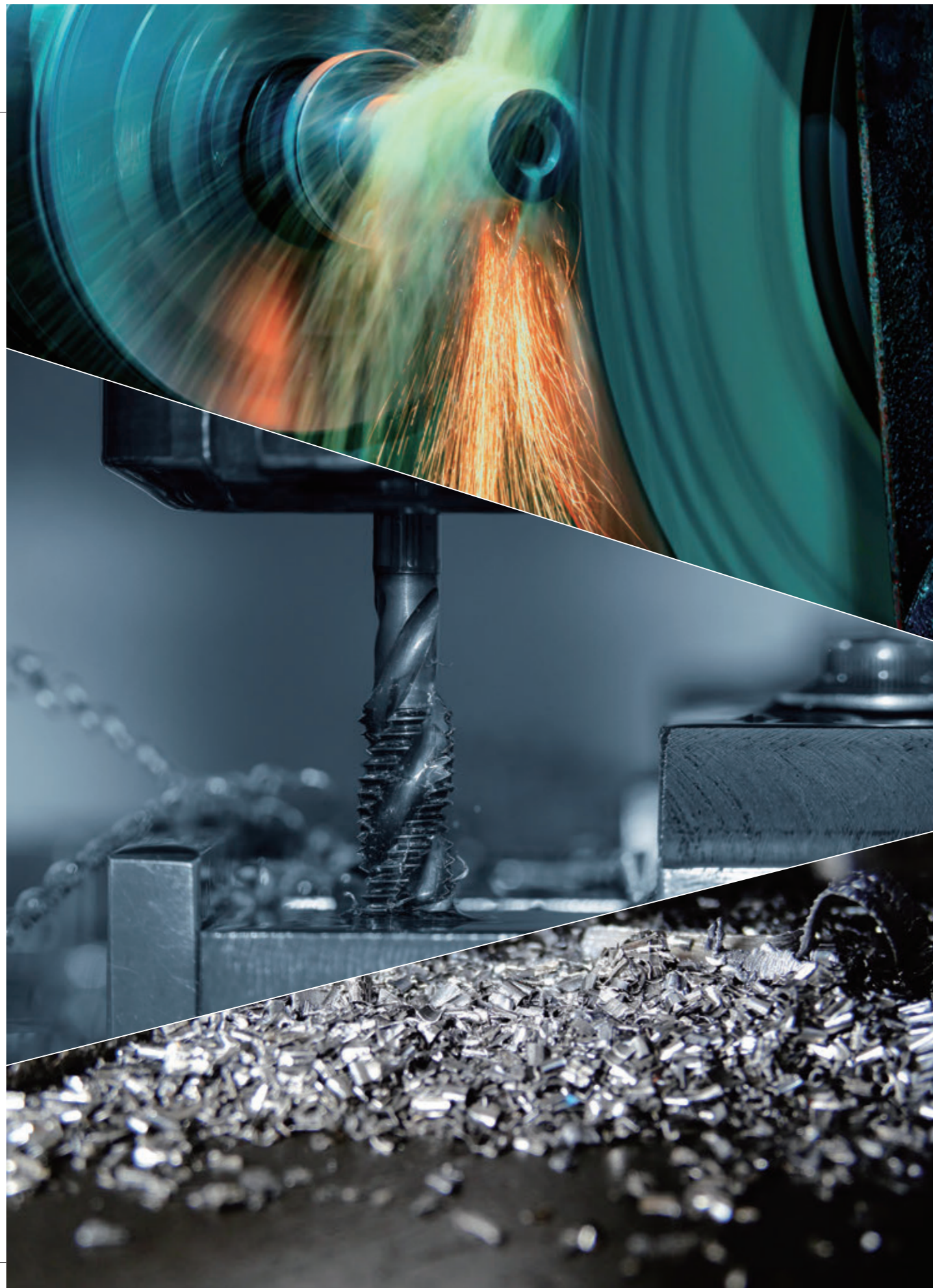

Maintains excellent performance in harsh environments C-Wiper specification provides excellent dust prevention

Linear Roller Way Super MX demonstrates superior performance in harsh environments where metal dust is scattered. Selecting the dust-prevention specification /RC with C-Wiper provides excellent dust-proofing that minimizes foreign substance contamination to maintain long-term performance. This dustproof performance also makes it suitable for use in clean environments where even the smallest foreign substance is not permitted.

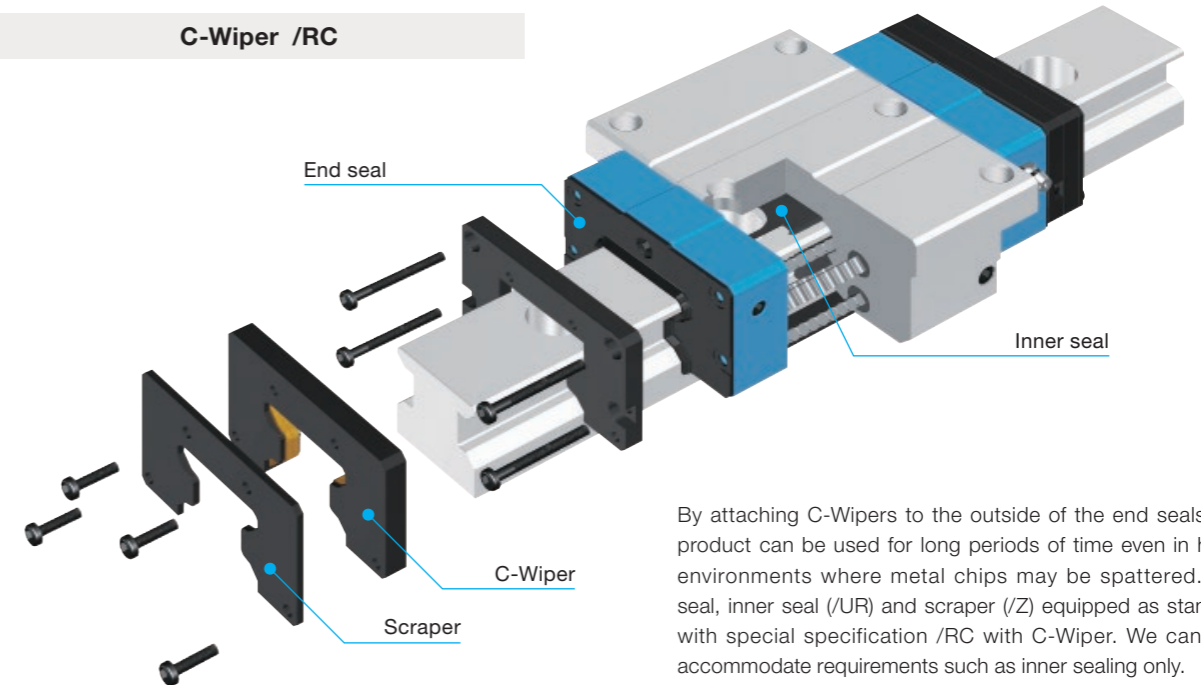

Durability test in environment with foreign substances

Test conditions

Test portion	MX35 T ₃ preload / caps for rail mounting holes and C-Wiper included
Maximum speed	18 m/min
Stroke length	500mm
Foreign substances	Fine metal chips Particle diameter 125 μm or less Hardness of 40-50 HRC Application dose 1 g/hr (total dose: 1 kg)

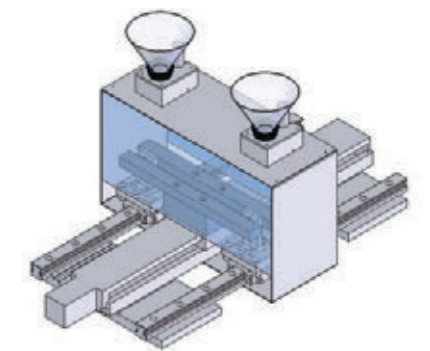

After operation of 1,000 km

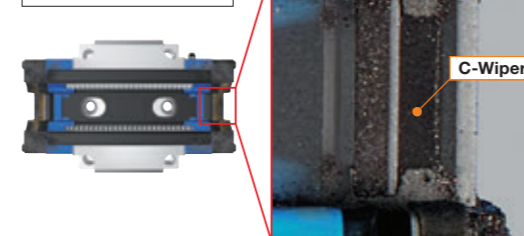

Very few foreign substances enter the slide unit.

After operation of 1,000 km

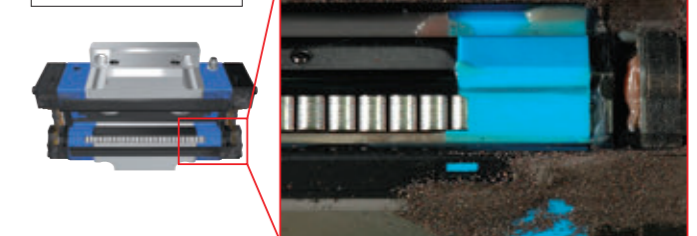

Almost no foreign substances enter the way

Supporting an advanced and prosperous society

Value provided by IKO products

How do IKO products solve the problems of machinery and equipment manufacturers and their users, and contribute to the advancement of a prosperous society?

Here are two examples of our products being used in machine tools and train platform doors that helps to improve daily life.

Case
study
1

Product used: **C-Lube Linear Roller Way Super MX Series**

Machine tools (machining center)

Machines that process and manufacture machine element parts with high precision and efficiency using metals and other materials. They are also called the "mother machine" because all machines and their parts are built using machine tools.

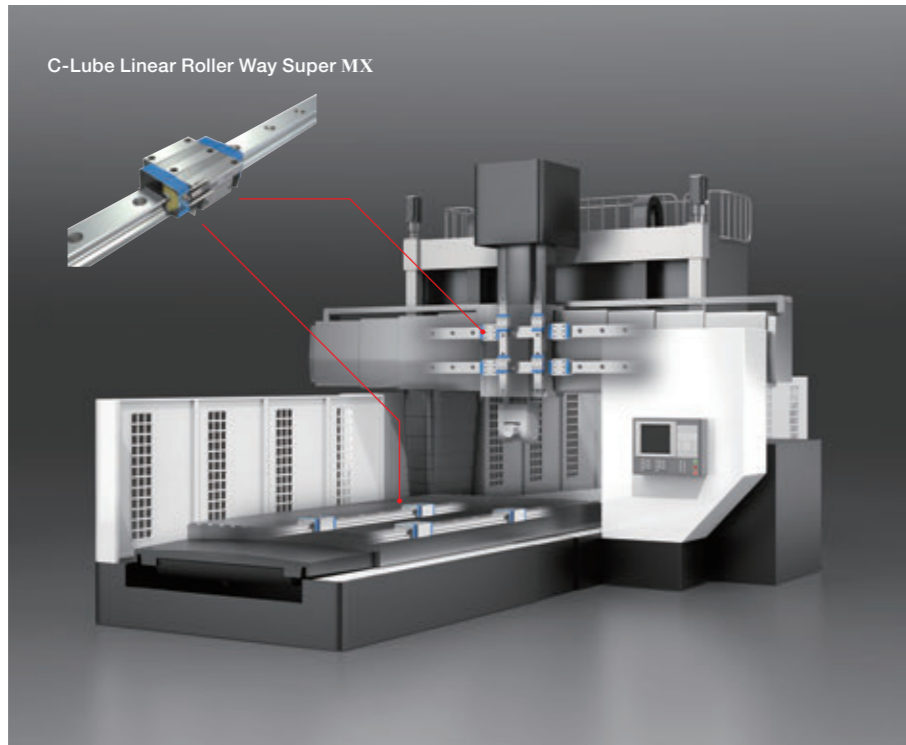

Details of use

Contributes to improved running accuracy and machining quality, as well as reducing the size of the machinery.

In addition to machining accuracy and speed, machine tools must be strong enough to maintain their value over the long term and have maintenance-free performance. In recent years, there has been an increasing need to downsize equipment as well.

In order to meet these performance requirements, one customer sought a compact, roller type linear motion rolling guide with a large load capacity and excellent running accuracy.

Among roller types, the Linear Roller Way Super X has significant advantages in high load capacity, high rigidity, small running deflection, and vibration damping performance.

Moreover, the MX type with C-Lube specifications provides maintenance-free performance. There is also the "Master Grade" option that offers minimal running deflection.

The superiority of the Linear Roller Way Super X as compared to other products was confirmed by the user's actual evaluation using a prototype machine. As a result, the customer decided to use IKO Linear Roller Way Super X for all X-, Y-, and Z-axes.

The fusion of the mechanism of the machine and the Linear Roller Way Super X leads to suppression of machine vibration and achieves excellent machining quality.

The customer was also pleased that it helped to reduce the size of the machinery and equipment to an extent that previously was not possible, allowing them to save significant floor space.

Case
study
2

Product used: **C-Lube Linear Roller Way Super MX Series**

Train platform door (sliding platform barrier)

A safety barrier to prevent falling onto the tracks or coming into contact with trains. Since 2016, when the Japanese government announced their policy of installing train platform doors in stations with an average of 100,000 passengers or more per day, they have become increasingly popular.

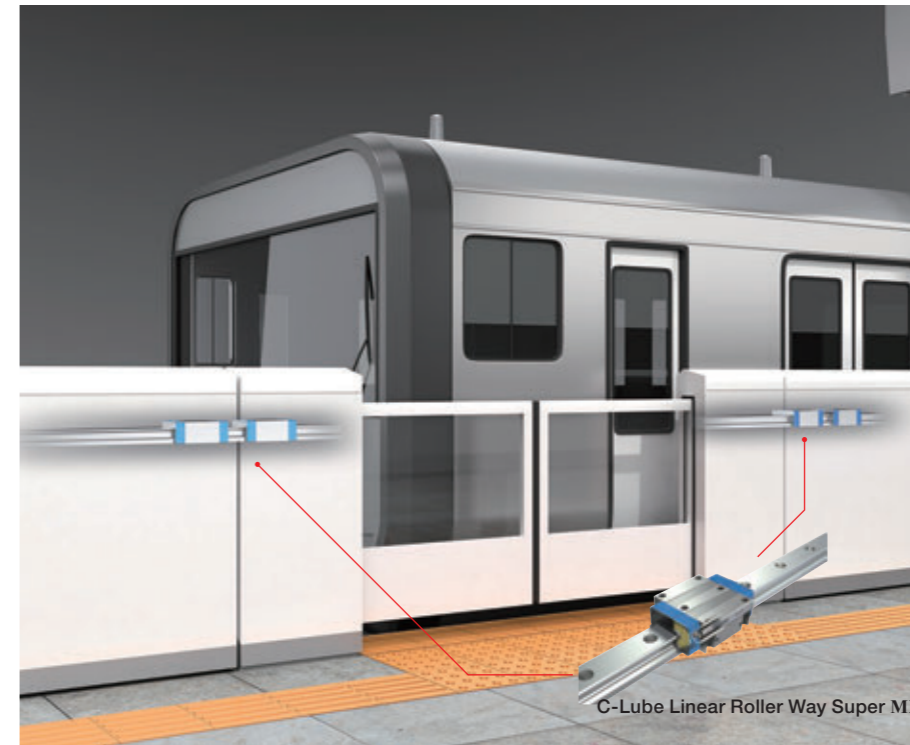

Details of use

Superior products that deliver safety while providing detailed solutions to customer requests.

Sliding doors installed on station platforms protect the safety of passengers as they board by opening and closing in time with the doors of arriving trains.

To prevent accidents of any kind, various safety systems, such as an obstruction detection function and a pry-open prevention function, are also provided.

To ensure the train platform doors operate safely, the linear motion rolling guide was required to have high load capacity and high rigidity to withstand not only shock load caused by the weight of the door, but also wind pressure caused when a train passes by and impact loads caused if a passenger bumps the door.

It also needed to be compact enough to be stored within the gate. These were important requirements to consider when choosing

between IKO's Linear Roller Way Super X and other competitors' products. As a result, Linear Roller Way Super MX was selected because it satisfied these requirements and also offered maintenance-free C-Lube, as well as IKO's own interchangeable specification which reduced waste and management labor hours. IKO also received high praise for its detailed support, including offering black chrome surface treatment for the units and rails as an anti-corrosion measure, providing case-studies and various test data, introducing examples of damage caused by insufficient lubrication, and prompt response to strength and life calculations.

Introduction of IKO Technical Service Site

<https://www.ikont.co.jp/eg/>

The "IKO Technical Service Site" can be accessed from the IKO homepage. The site also provides various tools for selecting Linear Ways and Linear Roller Ways. Please utilize these tools for assistance when selecting products. Additionally the site also provides CAD data and product catalogs for the Needle Roller Bearing Series, Linear Motion Rolling Guide Series and Mechatronics Series for download. Please utilize them to improve your design efficiency.



1. Technical Calculations

For Linear Way/Linear Roller Way load and life calculation, you can obtain the calculated load and the rating life by entering the operating conditions. Also you can derive the motor torque required for operation and the effective thrust force during operation in the sections of motor torque calculation and calculation of effective thrust force of linear motor tables respectively, and output the calculation results in PDF format, as well as save the histories.

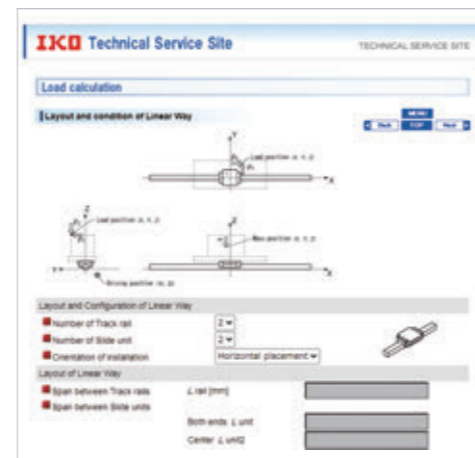

2. Selection of Identification Number

By selecting such specifications as model code, dimensions, part code, material code, preload symbol, classification symbol, interchangeable code and supplemental code of Linear Ways/Linear Roller Ways, you can easily specify the identification number used for ordering. Also you can browse the CAD data of the selected products, calculate the load, and output the selection results in PDF format, as well as save the histories.



3. Downloading CAD Data

2-dimensional CAD data (DXF file)
There are two types of figures: outline figures and detailed figures. The brief figure shows only the external view lines, and the detailed figure shows the detailed lines. Three drawings are provided: front view, side view and plan view. Available scale is original size only (1:1), and dimension lines are not shown.



3-dimensional CAD data
It is linked to the mechanical parts CAD library "PART community". Enter your rail length and specifications in the Detail area and then review the 2D/3D CAD data that meets those specifications, free of charge.

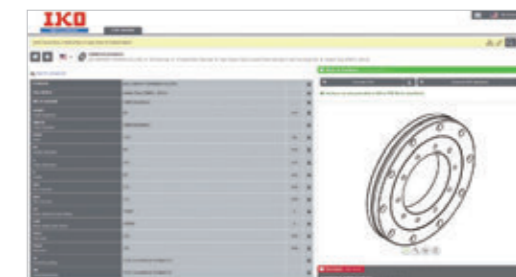

4. Product Catalog and Instruction Manual Downloads

You can download product catalogs for the Needle Series, Linear Motion Rolling Guide Series and Mechatronics Series, operation manuals of precision positioning tables and various electrical components in PDF format, as well as support software for Precision Positioning Tables. If you would like a printed catalog, please visit our website to request one, or contact your local branch or sales office.

5. Virtual Showroom

The IKO Virtual Showroom provides access to videos and the latest technical product information.

