

NIPPON THOMPSON CO., LTD. (JAPAN)

Head Office : 19-19, Takanawa 2-chome, Minato-ku,
Tokyo, 108-8586, Japan
Phone : +81 (0)3-3448-5850
Fax : +81 (0)3-3447-7637
E-mail : ntt@ikonet.co.jp
URL : <https://www.ikont.co.jp/eg/>
Plant : Gifu, Kamakura



IKO INTERNATIONAL, INC. (U.S.A.)

East Coast Operation (Sales Head Office)

91 Walsh Drive,
Parsippany, NJ, 07054,
U.S.A.
Phone : +1-973-402-0254
Toll Free : +1-800-922-0337
Fax : +1-973-402-0441
E-mail : eco@ikonet.co.jp



Midwest Operation

101 Mark Street, Unit-G,
Wood Dale, IL, 60191,
U.S.A.
Phone : +1-630-766-6464
Toll Free : +1-800-323-6694
Fax : +1-630-766-6869
E-mail : mwo@ikonet.co.jp

West Coast Operation

9830 Norwalk Boulevard, Suite 198,
Santa Fe Springs, CA, 90670,
U.S.A.
Phone : +1-562-941-1019
Toll Free : +1-800-252-3665
Fax : +1-562-941-4027
E-mail : wco@ikonet.co.jp

Silicon Valley Sales Office

1500 Wyatt Drive, Suite 10,
Santa Clara, CA, 95054,
U.S.A.
Phone : +1-408-492-0240
Toll Free : +1-800-252-3665
Fax : +1-408-492-0245
E-mail : wco@ikonet.co.jp

Southeast Operation

3235 Satellite Boulevard Building 400, Suite 230,
Duluth, GA, 30096,
U.S.A.
Phone : +1-770-418-1904
Toll Free : +1-800-874-6445
Fax : +1-770-418-9403
E-mail : seo@ikonet.co.jp

Southwest Operation

6191 N STATE HIGHWAY 161, STE 440,
IRVING, TX 75038-2264,
U.S.A.
Phone : +1-972-925-0444
Toll Free : +1-800-295-7886
Fax : +1-972-707-0385
E-mail : swo@ikonet.co.jp

IKO THOMPSON BEARINGS CANADA, INC.(CANADA)

731-2425, Matheson Boulevard East, 7th floor,
Mississauga, Ontario, L4W 5K4, Canada
Phone : +1-647-931-3933
E-mail : itc@ikonet.co.jp

IKO BRASIL SERVIÇOS EMPRESARIAIS LTDA. (BRAZIL)

Rua Frei Caneca 1407,
Condominio Edifício Barão de Monte Cedro,
Cjs. 801/802, Consolação, São Paulo- SP
Cep: 01307-909
Phone : +55 (0)11-2366-3033
E-mail : itb@ikonet.co.jp

NIPPON THOMPSON EUROPE B.V. (EUROPE)

The Netherlands (Sales Head Office)

Keersopstraat 35,
3044 EX, Rotterdam,
The Netherlands
Phone : +31 (0)10-462 68 68
E-mail : nte@ikonet.co.jp



Germany Branch

Mündelheimer Weg 54,
40472 Düsseldorf,
Germany
Phone : +49 (0)211-41 40 61
Fax : +49 (0)211-42 76 93
E-mail : ntd@ikonet.co.jp

Regensburg Sales Office

Im Gewerbepark D 04,
93059 Regensburg,
Germany
Phone : +49 (0)941-20 60 70
Fax : +49 (0)941-20 60 719
E-mail : ntdr@iko-nt.de

U.K. Branch

2 Vincent Avenue, Crownhill,
Milton Keynes, Bucks, MK8 0AB,
United Kingdom
Phone : +44 (0)1908-566144
E-mail : sales@iko.co.uk

Spain Branch

Autovia Madrid-Barcelona, Km. 43,700
Polig. Ind. AIDA - Nove A-8, Ofic. 2-1^a
19200-Azuqueca de Henares,
(Guadalajara) Spain
Phone : +34 949-26 33 90
Fax : +34 949-26 31 13
E-mail : nts@ikonet.co.jp

France Branch

Bâtiment le Raphaël-Paris, Nord 2,
22 avenue des Nations
BP54394 Villepinte
95943 ROISSY C.D.G Cedex
France
Phone : +33 (0)1-48 16 57 39
Fax : +33 (0)1-48 16 57 46
E-mail : ntf@ikont.eu

IKO THOMPSON ASIA CO., LTD. (THAILAND)

Unit 305,3rd Fl., Zuellig house, 1-7 Silom Rd.,
Silom Bangrak, Bangkok 10500, Thailand
Phone : +66 (0)2637-5115
Fax : +66 (0)2637-5116
E-mail : ita@ikonet.co.jp

IKO THOMPSON KOREA CO.,LTD. (KOREA)

201, Worldvision Bldg., 77-1, Yeouinaru-ro,
Yeongdeungpo-gu, Seoul, Korea
Phone : +82 (0)2-6337-5851
Fax : +82 (0)2-6337-5852
E-mail : itk@ikonet.co.jp

IKO-THOMPSON (SHANGHAI) LTD. (CHINA)

Shanghai (Sales Head Office)

2301-02, 2310, MetroPlaza No.555, LouShanGuan
Road, ChangNing District, Shanghai,
People's Republic of China, 200051
Phone : +86 (0)21-3250-5525
Fax : +86 (0)21-3250-5526
E-mail : ntc@ikonet.co.jp

Beijing Branch

Room 1909, Tower C Oriental Media Center,
Guanghua Road No. 4 Chaoyang District, Beijing,
People's Republic of China, 100026
Phone : +86 (0)10-6515-7681
Fax : +86 (0)10-6515-7689
E-mail : ntc@ikonet.co.jp

Guangzhou Branch

Room 834, Garden Tower, Garden Hotel
368 Huanshi East Road, Yuexiu District, Guangzhou,
Guangdong
People's Republic of China, 510064
Phone : +86 (0)20-8384-0797
Fax : +86 (0)20-8381-2863
E-mail : ntc@ikonet.co.jp

Wuhan Branch

Room 834, Truroll Plaza No.72, Wusheng Road,
Qiao kou District, Wuhan, Hubei,
People's Republic of China, 430033
Phone : +86 (0)27-8556-1610
Fax : +86 (0)27-8556-1630
E-mail : ntc@ikonet.co.jp

Shenzhen Branch

Room1808, KEENSTAR Building 18,
Chuangye 2nd Rd 248, Bao'an, Shenzhen, Guangdong,
People's Republic of China, 518081
Phone : +86 (0)755-2265-0553
Fax : +86 (0)755-2298-0665
E-mail : ntc@ikonet.co.jp

Xian Branch

Room 2010, Block B, Chaoyang International Plaza,
No. 166,
Changle West Road, Xincheng District Xi'an, Shanxi,
People's Republic of China, 710032
Phone : +86 (0)29-8323-5915
E-mail : ntc@ikonet.co.jp

Qingdao Branch

Room 608, Building 47, Huarun City,
No. 101 Shenzhen Road, Laoshan District,
Qingdao City, Shandong
People's Republic of China, 266100
Phone : +86 (0)532-8670-2246
Fax : +86 (0)532-8670-2242
E-mail : ntc@ikonet.co.jp

Shenyang Branch

2-1203 Tower I, City Plaza Shenyang NO.206,
Nanjing North Street, Heping District,
Shenyang, Liaoning
People's Republic of China, 110001
Phone : +86 (0)24-2334-2662
Fax : +86 (0)24-2334-2442
E-mail : ntc@ikonet.co.jp

Ningbo Office

Room 3406, Zhongnongxin Building, No.181,
Zhongshan East Road, Haishu District,
Ningbo, Zhejiang
People's Republic of China, 315000
Phone : +86 (0)574-8718-9535
Fax : +86 (0)574-8718-9533
E-mail : ntc@ikonet.co.jp

IKO



IKO Products for Medical Equipment

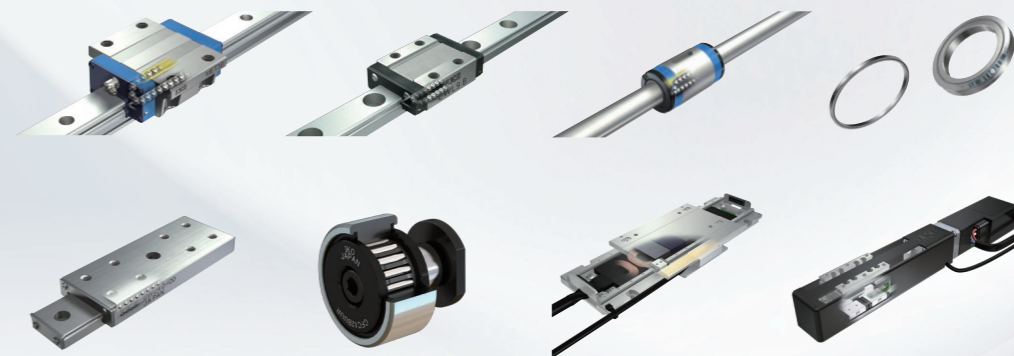

• The specifications and dimensions of products in this catalog are subject to change without prior notice. • When these products are exported, the exporter should confirm a forwarding country and a use, and, in case of falling under the customer's requirements, take necessary procedures such as export permission application. • Although all data in this catalog has been carefully compiled to make the information as complete as possible, NIPPON THOMPSON CO., LTD. shall not be liable for any damages whatsoever, direct or indirect, based upon any information in this catalog. NIPPON THOMPSON CO., LTD. makes no warranty, either express or implied, including the implied warranty of merchantability or fitness for a particular purpose. • Reproduction and conversion without permission are prohibited.



ISO 9001 & 14001 Quality system registration certificate

Compact, High-Accuracy, Stainless Steel for All Linear Guiding Parts

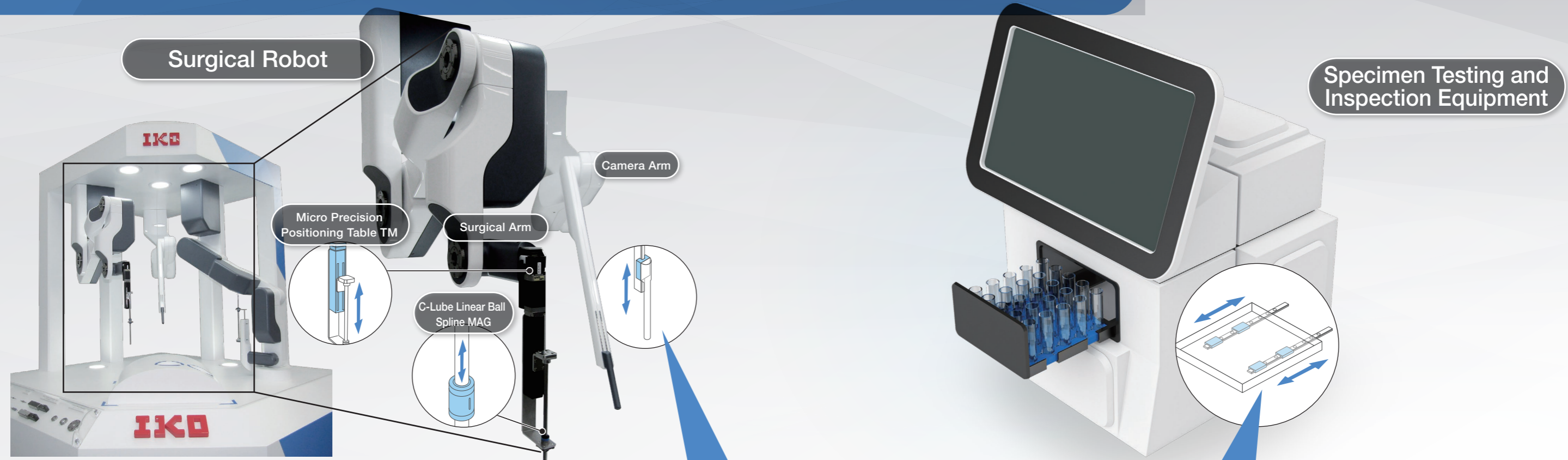

Miniature Linear Way Series

C-Lube Linear Way ML

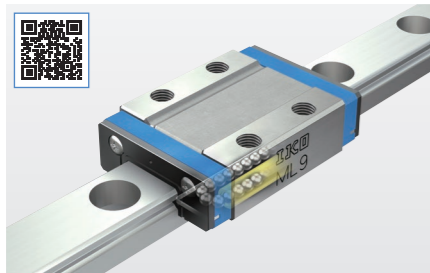

Thanks to a design featuring two rows of balls that contact the raceway at four points, stable accuracy and rigidity can be achieved despite the unit's small size. This is true even in applications where loads have variable direction and size or complex load is applied. A wide variety of shapes and sizes are available, enabling selection based on the specific application.

Size	
Standard type	5, 7, 9, 12, 15, 20, 25

Standard type
ML
LWL

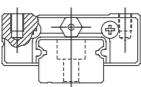

Length of slide unit	
C	Short
No symbol	Standard
G	Long
L	Extra long



IKO's proprietary solid lubricant, C-Lube, is impregnated with a large volume of lubrication oil to provide over 20,000km of operation without the need for relubrication. This makes the device maintenance-free for the life of the bearing.

Structure

Lubrication oil is continuously supplied to the surface of the rolling elements via surface tension without contacting the track rail.

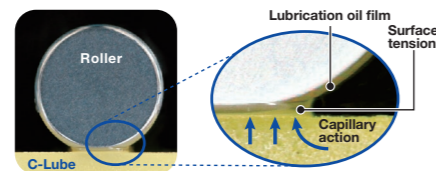

C-Lube Linear Way ML

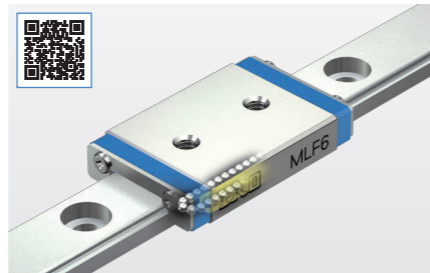

Size	
Wide rail type	10, 14, 18, 24, 30, 42

Wide rail type
MLF
LWLF

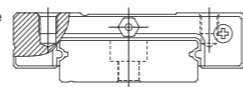

IKO offers a them ideal for use

Corrosion Resistance

For highly corrosion-resistant stainless steel specifications, this product is suitable for use in cleanrooms and applications where rust prevention oil cannot be used.

Wide Rail Type



Maintains the same performance as C-Lube Linear Way ML, but this unit's overall length and width (W) have been increased, along with the load rating and allowable moment. Stable accuracy and smooth movement can be achieved even when complex loads are applied.

Length of slide unit	
C	Short
No symbol	Standard
G	Long

Standard type
ML
LWL



wide range of stainless steel specification products as standard, making in applications where oil and rust prevention oil must be avoided.

Special Orders

Products for which stainless steel specifications are not standard can be individually manufactured. Please contact IKO for details.

Micro Linear Way L

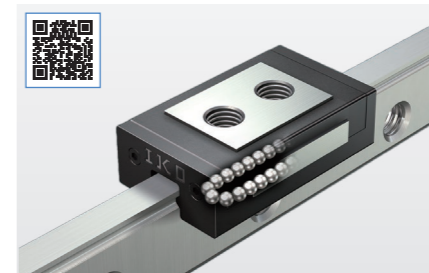

Size	
Standard type	1, 2, 3
Wide rail type	2, 4, 6

Standard type
ML
LWL



Created with proprietary miniaturization technology, Micro Linear Way L is available in track rail widths from 1 to 6 millimeters. High micro-positioning is attained with linear way accuracy, making the micro-sized unit optimal in locations where reliability is required.

Ultra-Small Rail Width of 1mm!

With its ultra-small size, LWL1 supports the super miniaturization of machines and devices required for designs of today and for the future.

Even the smallest size of 1mm* features:

- High accuracy
- Secure mounting and fixing**
- Stable operation

*Track rail width of 1 mm **Tapped rail specifications

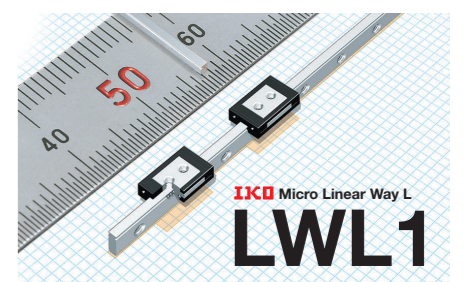

CT Scanner

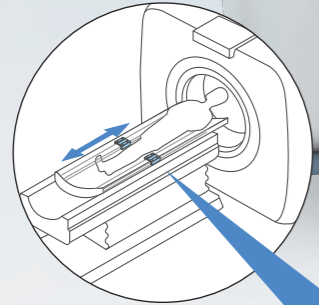

Bath Lifts

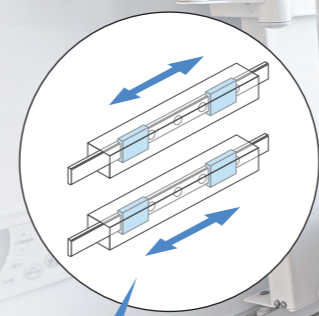

Linear Way/Linear Roller Way Series

C-Lube Linear Way ME

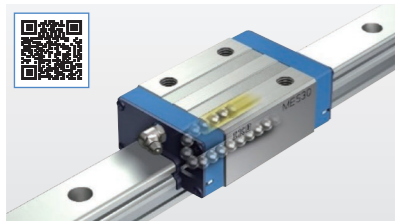

This standard linear motion rolling guide is compact and highly versatile. Low-decibel designs with a resin separator are also available to prevent direct contact between balls. A wide variety of shapes and sizes support various uses, enabling the selection of an ideal design for your application.

Size
15, 20, 25, 30, 35, 45

Length of slide unit	
C	Short
No symbol	Standard
G	Long

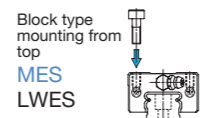
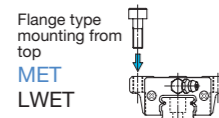
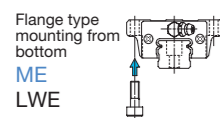

IKO linear products feature compact designs and simple structures.

Simple Structure

All Linear Way series adopt two-row raceways with four-point contact. Their simple structure contributes to miniaturization and provides smooth and highly precise action.

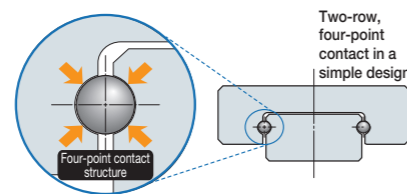

C-Lube Linear Way MV

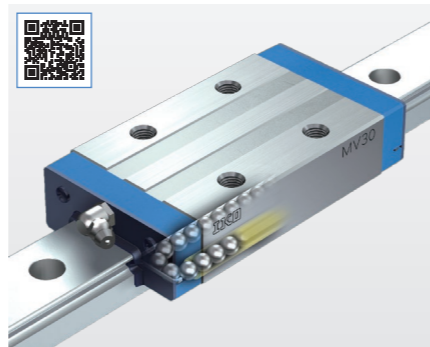

The ultimate ball-type linear motion rolling guide features an extra-low profile and extra-light weight, achieved through the simple design of two-row raceways with a four-point-contact structure. Despite its low profile and weight, this guide has the maximum load rating among ball types and contributes to the long life and safety of machines and devices.

Size
20, 25, 30

Length of slide unit	
Standard	

High Load Capacity

This linear motion rolling guide features high load capacity with the highest downward load rating among ball-type models.

Low Profile

Low sectional height compared to the ME and MH Series helps keep machinery and equipment compact.

Sectional height comparison (Size 25)

76% lower cross sectional height compared to the ME Series

69% lower cross sectional height compared to the MH Series*

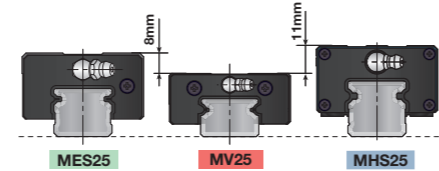

* Excluding the MHD Series with block-type mounting from the top.

C-Lube Linear Roller Way Super MX

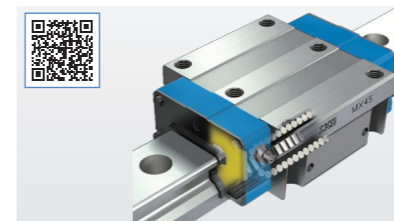

This extra-long unit with maximum slide unit length utilizes superior characteristics including rigidity, load capacity, running accuracy and vibration damping to achieve the highest performance levels.

Size
10, 12, 15, 20, 25, 30, 35, 45, 55, 65, 85, 100

Length of slide unit			
C	No symbol	G	L
Short	Standard	Long	Extra long

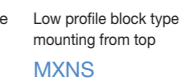
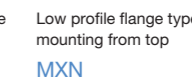
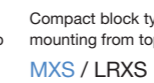
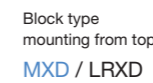
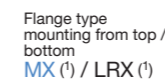

Super High Rigidity

The rigidity of a linear motion rolling guide significantly improves machine and device performance. Linear Roller Way Super X's superior accuracy and smooth running is achieved with small cylindrical rollers with less elastic deformation under load.

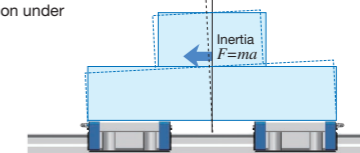

Comparison of elastic deformation

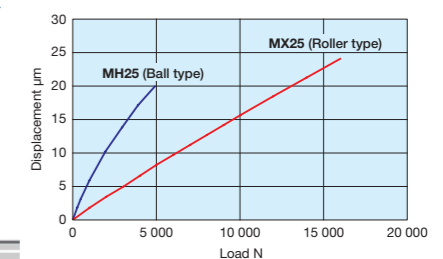

Compact Size, High Accuracy, Smooth Motion for Lens Focus Mechanisms and More

Controller for Surgical Robots

Retinal Diagnostic Solutions

Linear Slide Series

High-Precision Linear Slide Unit

COMPACT STAINLESS



This small unit with limited stroke features balls and a retainer between an integrated table and bed. It makes contact with the raceway at four points, providing accuracy and rigidity in applications where a fluctuating or complex load is applied.

unit: mm

Shape	Model	Width	Length													
			10	15	20	25	30	40	45	60	75	80	90	100	120	
	BWU	6	○	—	○	—	○	—	—	—	—	—	—	—	—	—
		8	○	—	○	—	○	—	—	—	—	—	—	—	—	—
		10	—	○	—	○	—	○	—	—	—	—	—	—	—	—
		12	—	—	○	—	○	—	○	—	—	—	—	—	—	—
		17	—	—	—	○	—	○	—	○	—	—	—	—	—	—
		25	—	—	—	—	○	—	○	—	○	—	—	—	—	—
		30	—	—	—	—	—	○	—	○	—	○	—	—	—	—
		60	—	—	—	—	—	—	—	—	○	—	○	—	—	○

Ideal for Use in Cleanrooms

Optimal linear guides for machinery and equipment used in cleanrooms and other locations requiring high cleanliness, all components — table, balls, cage, bed, end stopper, etc. — employ stainless steel for excellent corrosion prevention and heat resistance.

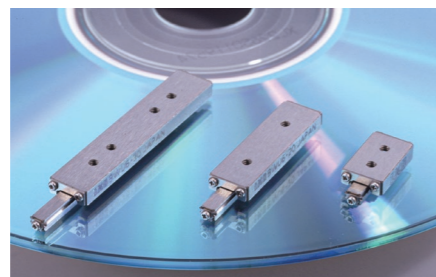

Precision Linear Slide Unit

COMPACT STAINLESS

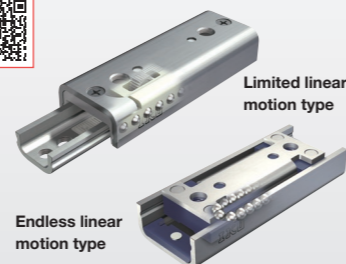

This extremely compact and lightweight unit with the way and mounting surface integrated has been made by precisely molding a stainless steel plate into a U shape. A wide range of applications are supported in both the limited linear motion type, which features smooth motion, and the endless linear motion type, featuring a long stroke.

Shape	Model	Width					
		7	10	12	15	20	25
Limited linear motion type	BSP	○	○	—	○	○	○
Endless linear motion type	BSR	—	—	○	○	○	○

Smooth, Quiet Motion

The superior retaining and guiding mechanism of the balls and precision-finished raceway surface produces extremely quiet, low-friction linear motion. High response characteristics and positioning accuracy are obtained for micro-feeding operations as well.



Precision Linear Slide With Built-In Rack & Pinion

COMPACT STAINLESS

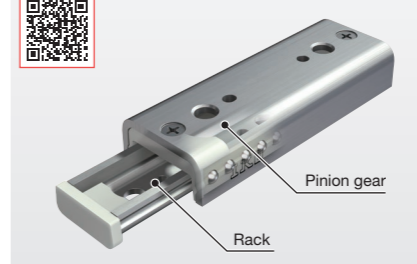

A pinion gear assembled in the retainer is integrated with a stud diameter ball raceway that is engaged with the racks fixed to the table and bed to prevent creeping of the retainer position. Like the BSP, this type also achieves smooth linear motion.

Shape	Model	Width					
		7	10	12	15	20	25
Built-in rack and pinion type	BSPG	—	—	○	○	○	○

High Accuracy and Stable Performance

A two-row steel ball array makes contact with the raceway at four points, providing stable load capacity in all directions. The simple structure also has low machining and mounting error, enabling long-term, high-motion accuracy.



Simple and Capable of Complex Loads

Multi-functional Small-size Automatic Analysis Equipment



Linear Ball Spline Series



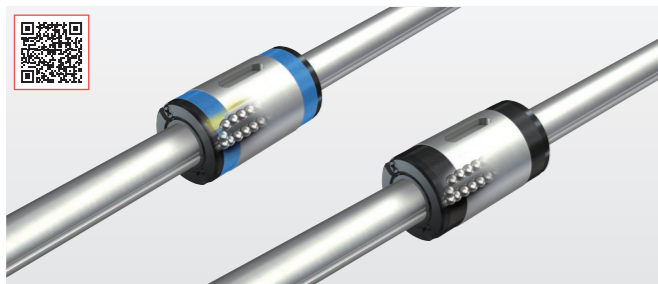

C-Lube Linear Ball Spline MAG/Linear Ball Spline G

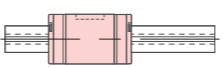

Since the structure has balls rotating on the spline track groove, it receives not only radial load but also rotating torque. Since the torque is transmitted with high rigidity, it provides smooth linear motion. The linear ball spline is also extremely compact, thanks to its simple structure.

Size	
Standard type	2, 3, 4, 5, 6, 8, 10, 12, 15, 20, 25, 30
Flange type	2, 3, 4, 5, 6, 8, 10, 12, 15, 20, 25, 30

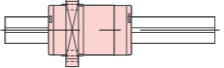
*1 For some model numbers, the spline shaft material can be changed to stainless steel as an optional setting.

	External cylinder length	
	Standard	Long
No symbol		
		

Standard type Solid shaft MAG LSAG	Flange type Solid shaft MAGF LSAGF	Standard type Hollow shaft MAGT LSAGT	Flange type Hollow shaft MAGFT LSAGFT
--	--	---	---

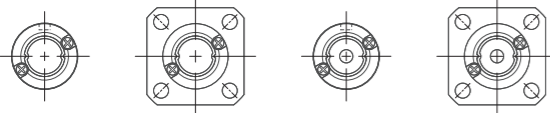

High Rigidity in a Compact Size

A structure featuring large-diameter balls in two rows with four-point track contact allows for greater rigidity and a compact design.

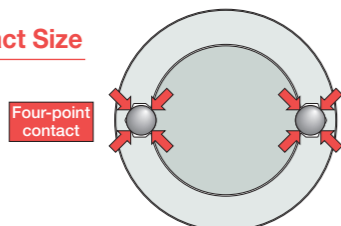

High Accuracy and Precise Positioning

Preload removes the clearance along the rotation direction, allowing for accurate positioning.

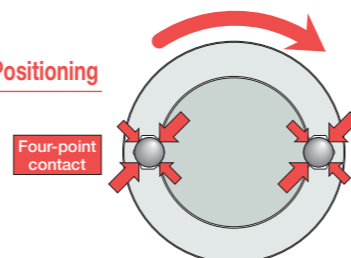

Low Frictional Resistance and Smooth Motion

This optimal design based on thorough analysis of ball recirculating routes achieves low frictional resistance and smooth linear motion for high-speed operations.

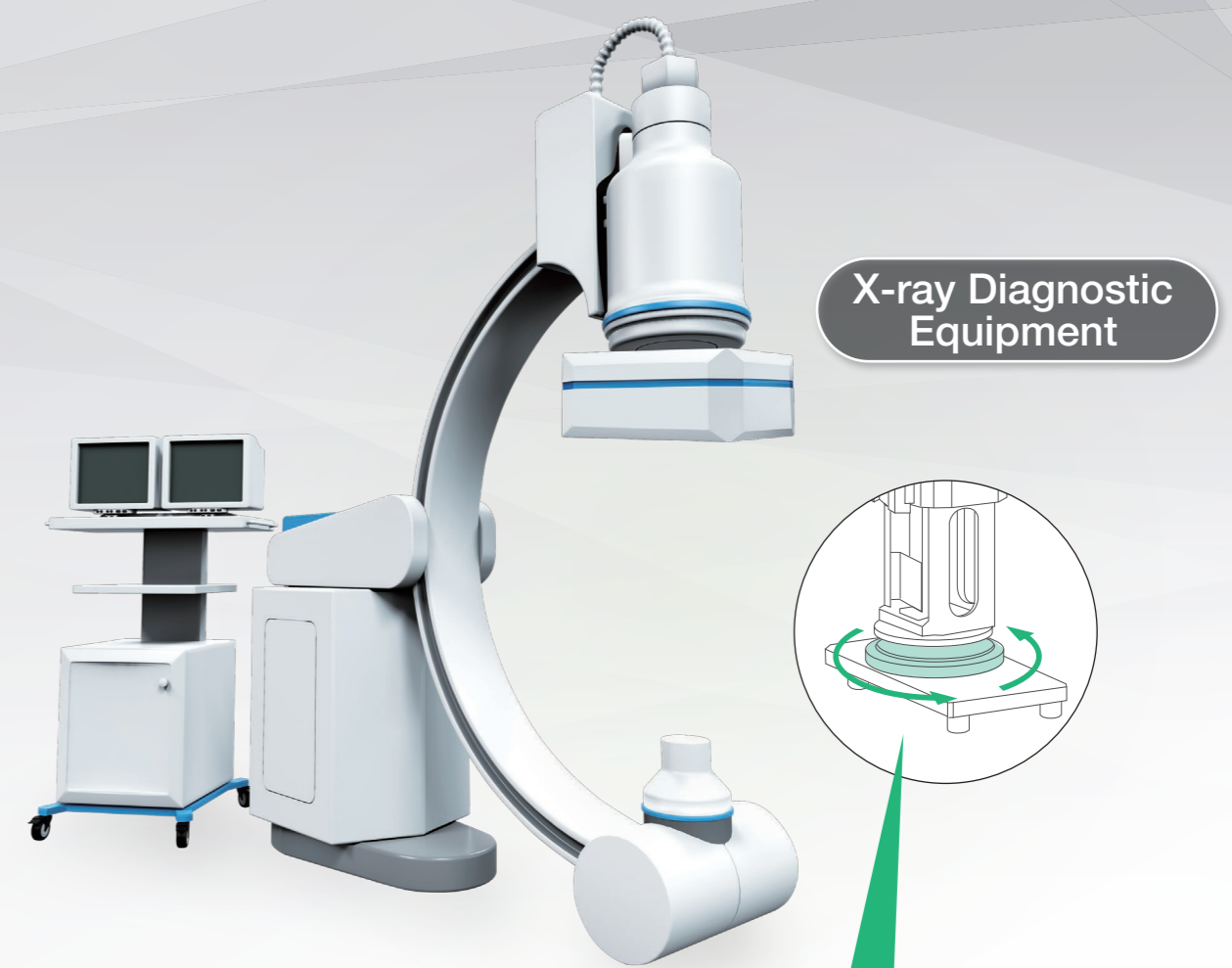

Crossed Roller Bearings Series

High Rigidity Crossed Roller Bearings V

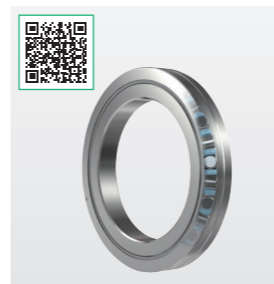

Crossed Roller Bearings are compact bearings with their rollers alternately crossed at right angles to each other between inner and outer rings. They can take loads from any direction at the same time, such as radial, axial, and moment loads. The rollers make line contact with raceway surfaces and, as a result, elastic deformation due to load is very low. They are widely used in the rotating parts of medical equipment and similar devices requiring a compact size, high rigidity and high rotational accuracy.

Size	Variation				
	Shaft dia. 20-250mm				
Seal	Yes		None		
Clearance	T1 (Preload)		C1 (Slight)	C2 (Medium)	
Accuracy class	Class 0	P6 RP6	P5 RP5	P4 RP4	P2 RP2
Accuracy	→ High				

Diverse Special Products Available Upon Request

IKO's multi-model production approach provides unique flexibility, enabling Crossed Roller Bearings to be customized based on individual specifications and application usage. Past special orders include shapes, sizes, surface treatments, and more, not available as standard.

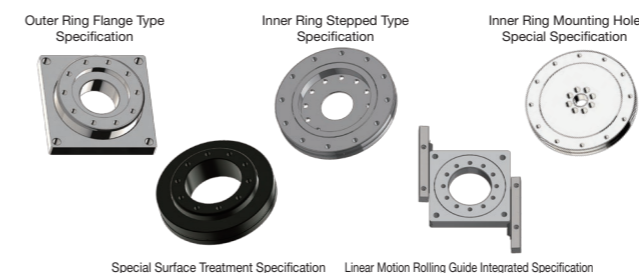

Mounting Holed Type Super Slim Crossed Roller Bearings

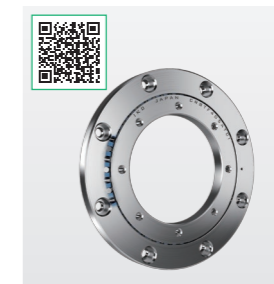

Made possible thanks to IKO's technological expertise in miniature bearing production, these bearings have an ultra-slim width of 5 millimeters. Because the built-in equipment rotation guiding parts have been made more compact, dynamic load is lighter during operation, saving energy and contributing to carbon-neutral operation.

Variation	
Size	Shaft dia. 10-40mm
Seal	None
Clearance	C1 (Slight)
Accuracy class	No symbol (P6 equivalent)

Easy Bolt-On Mounting Eliminates Complex Mounting Procedures.

Mounting Holed Type Super Slim Crossed Roller Bearings can be mounted directly to the mounting surface. No housing or pressure plate required.

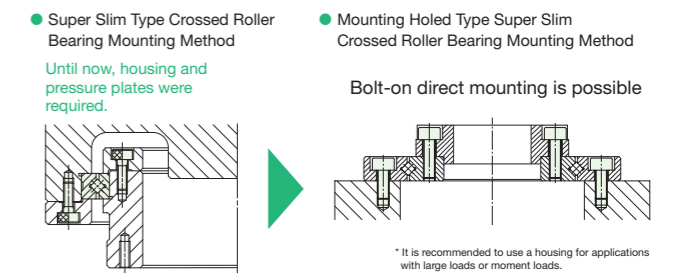

* It is recommended to use a housing for applications with large loads or moment loads.

A Variety of Cam Follower Options for Various Conveyor Parts

Specimen Tray
Conveyor Part



Pharmaceutical Conveyor Part



Cam Follower Series

Standard Type Cam Followers CF...B

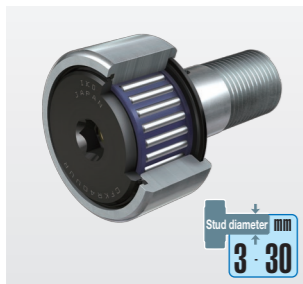

Cam Followers are bearings with a stud incorporating needle rollers in a thick-walled outer ring. They are designed for outer-ring rotation with superior rotational performance, a low friction coefficient, and high load capacity. Standard Type Cam Followers CF...B, the basic cam follower model, are available in a wide range of sizes with stud diameters ranging from 3 to 30 millimeters.

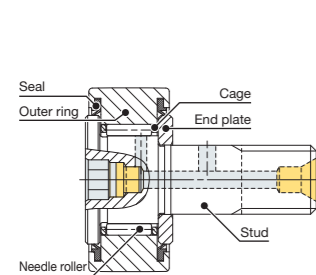

Type of material	No symbol	High carbon steel
	F	Stainless steel
Roller guide method	No symbol	With cage
	V	Full complement
Seal structure	No symbol	Shield type
	UU	Sealed type
Shape of outer ring outside surface	No symbol	Cylindrical outer ring
	R	Crowned outer ring

Miniature Cam Followers CFS, CFS...W

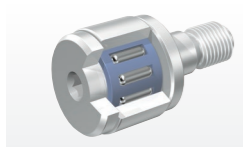

An ultrafine needle roller is incorporated into the bearing outer ring, attaining a compact design with an outer-ring outside diameter that is small relative to the stud diameter. Used in electronic devices, OA equipment, small index devices, etc.

Cam Followers with a stud diameter of just **1.4mm!**



Short Stud Type Cam Followers CFC



Short Stud Cam Followers CFC...B have a new mounting structure featuring a hexagon socket head bolt and a dedicated flange nut (patent pending). This structure maintains the performance of the cam follower while making it more compact and mountable. Since CFC...B needs far less mounting space than conventional cam followers, it enables greater design freedom, improving production efficiency in a wide range of industries.

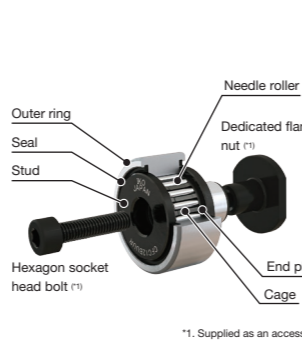

Type of material	No symbol	High carbon steel
	F	Stainless steel
Roller guide method	No symbol	With cage
	V	Full complement
Seal structure	No symbol	Shield type
	UU	Sealed type
Shape of outer ring outside surface	No symbol	Cylindrical outer ring
	R	Crowned outer ring

Standard Type Cam Followers CF 8 BUUR

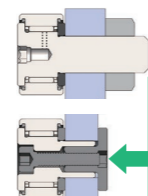

Short Stud Type Cam Followers CFC 8 BUUR

Overall length
For stud dia. 8 mm
reduced by 34%*

* Length when mounting member material thickness is set at the minimum value.

C-Lube Cam Followers CF.../SG C-Lube Unit CL

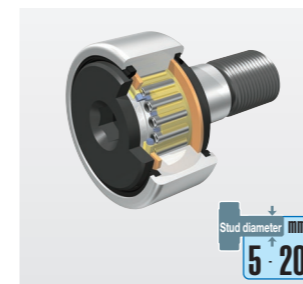

These maintenance-free Cam Followers are pre-packed with C-Lube. Comprised of lubrication oil and fine particles of super-high molecular polyolefin resin that are thermally solidified, C-Lube oozes onto the raceway in a controlled release as the outer ring rotates, maintaining long-term lubrication performance inside the cam follower.

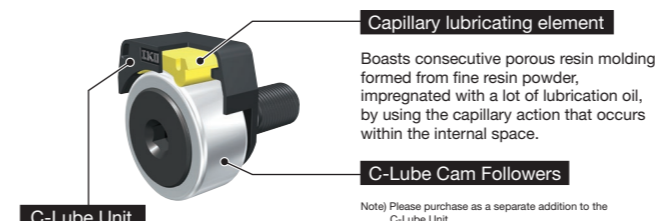

Ideal Combination - C-Lube Units and C-Lube Cam Followers

The combination of C-Lube Cam Followers CF...WB.../SG and C-Lube Units for Cam Followers CL offer maintenance-free operation and long life.

Regular lubrication is not required since the cam follower is prepacked with a solid type lubricant that provides sustained lubrication performance for a long period of time.

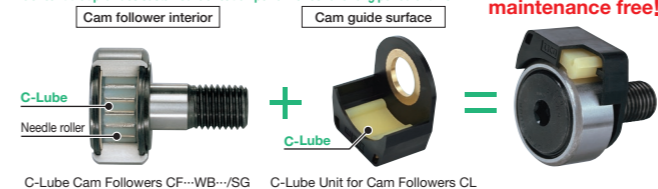

Completely maintenance free!

CFL Cam Followers with Resin

Extremely compact CFL Cam Followers with Resin have an embedded outer ring integrally molded from resin. Both self-lubricating and shock-absorbing types are available, depending on your application.



Self-lubricating type (POM)

- Less deformation than the shock-absorbing type, with high allowable load
- Resin with high lubrication is used, enabling smooth guidance

Stud diameter mm	Identification number
6	CFL 6PBJ
8	CFL 8PBJ
10	CFL10PBJ
12	CFL12PBJ



Shock-Absorbing Type (TPU)

- Elastic urethane rubber (Shore hardness A90) absorbs shock and vibration.
- Lactone-based polyurethane provides excellent mechanical properties and hydrolysis resistance.

Stud diameter mm	Identification number
6	CFL 6TBJ
8	CFL 8TBJ
10	CFL10TBJ
12	CFL12TBJ

Quiet

The resin absorbs vibration and suppresses noise during rotation. A quiet environment can be maintained without covers or sheets.

Scratch-proof

Unlikely to scratch the opposite surface, it prevents workpiece damage or scratching. Also ideal for shipping completed precision equipment.

Maintenance-Free

Long-term use is possible without greasing the outside diameter surface. Prevents contamination of the surrounding environment.

As a High-Accuracy Positioning Mechanism Module

Medical Imaging Analysis Equipment

Cell Testing and Inspection Equipment

Specimen Analysis Equipment

Positioning Tables

<Linear motor drive>

Nano Linear NT...V

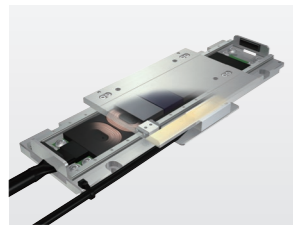

Offering superb cost-performance and an ultra-compact configuration, the NT...V linear motor table contributes to further miniaturization of positioning mechanisms. It supports various motion network drivers, and reduces wiring for smooth, high-speed and highly accurate motion.

Model and size	Standard Type NT...V		
	NT38V	NT55V	NT80V
Maximum thrust N	3	25	36
Rated thrust N	0.6, 0.8	7	8
Maximum load mass kg	0.5	5	5
Effective stroke length mm	10, 18	25, 65	25, 65, 120
Resolution μm	0.1	0.5	0.1
Maximum speed mm/s	270	500	270
Positioning repeatability μm	± 0.5	± 0.5	± 0.5

Ultra-Compact

NT...V achieves the ultimate in compactification. The NT38V10, the smallest in the series, is only 11mm in sectional height, 38mm in table width, and 62mm in overall length. The occupied space does not increase even when many tables are layered, so miniaturization of the positioning mechanism is promoted.

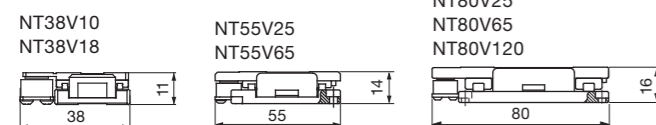

Nano Linear NT88H

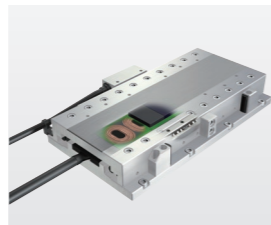

NT...H is a high-accuracy linear motor table with high rigidity and smooth motion, without pulsation as compared with air static pressure bearings. Positioning accuracy and running straightness are below $1\mu\text{m}$ because it uses a roller-type built-in rack and pinion Crossed Roller Way in the table guiding parts.

Model and size	High Accuracy Type NT...H	
	NT88H25	NT88H65
Maximum thrust N	25	25
Rated thrust N	5	5
Maximum load mass kg	5	5
Effective stroke length mm	25	65
Resolution μm	0.01	0.05
Maximum speed mm/s	90	400
Positioning repeatability μm	± 0.1	± 0.1

Superior Attitude Accuracy, Speed Stability, and Running Accuracy

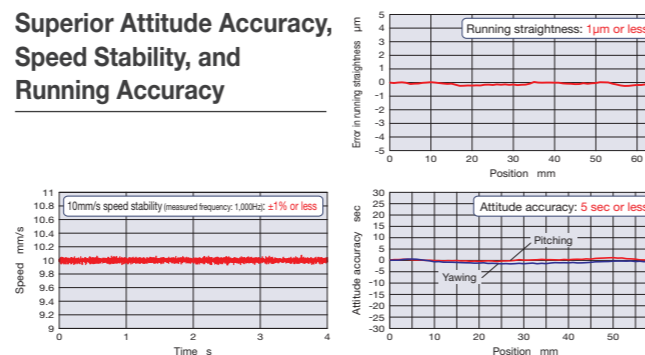

<Ball screw drive>

Micro Positioning Table TM



Featuring a Micro Linear Way L with a rail width of 2mm in the table guiding parts and a miniature ball screw with a diameter of 2mm in the feeding mechanism, the ultra-small TM is unparalleled among ground ball screw drive positioning tables. It is ideal for situations requiring high accuracy and a compact size not available in other compact positioning tables.

Maximum speed: 15-75mm/s
Maximum carrying mass: 0.7-1.5kg
Positioning repeatability: $\pm 2\pm 1\mu\text{m}$

Model	Shape of slide table	Table width [mm]	Table height [mm]	Stroke length [mm]
TM15-20	Standard table	15	20	20
TM15-40				40
TM15-60				60
TM15G-10	Long table	15	20	10
TM15G-30				30
TM15G-50				50

Tables can be specified according to your use.

There are two types of slide tables — standard and long. Two Micro Linear Ways L with two slide units have been incorporated in parallel into the long table, so it is structurally resistant to moment and complex load.



Cleanroom Positioning Table TC



TC is a positioning table based on the lightweight, low profile, and compact Precision Positioning Table TE, but features a structure that provides enhanced sealing inside the table. Thanks to the optimal design that uses a linear motion rolling guide and ball screw, cross-sectional height as low as 50mm for TC50EB, 54mm for TC60EB, and 67mm for TC86EB is realized. The sensor is designed to be directly mounted into the mounting groove which also contributes to space saving.

Maximum speed: 120-1000mm/s
Maximum carrying mass: 5-36kg
Positioning repeatability: $\pm 2\mu\text{m}$

Example of measurement data [Upper concentration limit chart for each cleanliness class]

Model and size	Bed length	Ball screw lead	Stroke	Speed	Suction amount	Cleanliness class (ISO 14644-1)
TC50EB	150	4	50	200	5	Class 2
	200	4	100	200	10	Class 2
	300	8	200	400	10	Class 2
TC60EB	150	5	50	250	30	Class 3
	300	10	200	500	30	Class 3
	600	10	500	500	30	Class 3
TC86EB	340	10	200	500	30	Class 3
	640	10	500	500	40	Class 3
	640	20	500	1000	70	Class 3

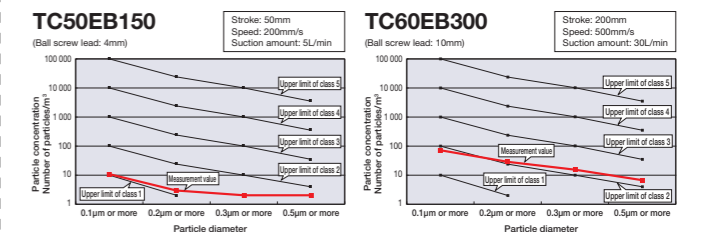

Support for Special Environments

Precision Cleaning/Clean Packaging Specifications

We offer support for precision cleaning and assembly, inspection and packaging conducted in environments with controlled cleanliness. Work is done in an ISO14644-1 (cleanliness class 6) environment, suited to packaging products used with equipment in clean environments and high-vacuum environments. Consider these options in combination with stainless steel products with high rust prevention capacity and the Liquid Crystal Lubricant Series with excellent dust suppression.

Everything from assembly through packaging conducted in a clean environment!

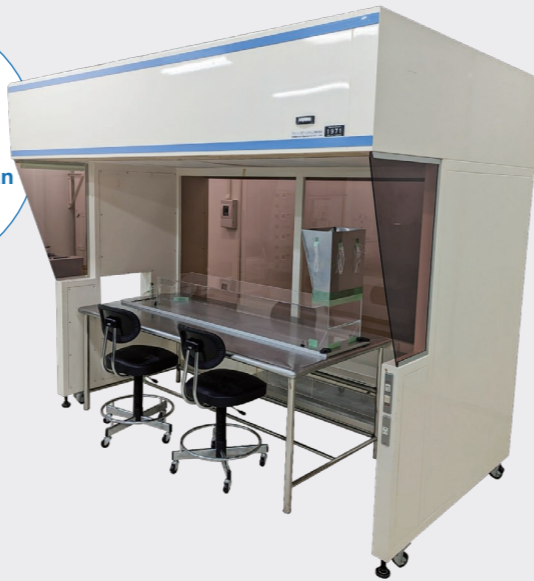

Features

High Cleanliness

Because everything from assembly through inspection to packaging is conducted in the same ISO-compliant cleanroom, there is no risk of contamination between processes so high cleanliness is realized.

Diverse Packaging Specifications

Low-dust dedicated packaging paper is used. Special packaging is also available upon request. For detailed information, please contact IKO.

Reduced Acceptance Processes

Because the product is packaged in a clean environment, customers may forgo the typical cleaning process. After unpacking, the product can be assembled as-is onto the equipment in the vacuum environment where it is to be used.

Applicable products

- Compatible series
- Linear Way L Series
 - Linear Way E Series
 - Linear Way H Series
 - Linear Way F Series
 - Linear Roller Way Super X Series



Support for other linear motion rolling guide series or Needle Roller Bearing Series not listed above is also available. For detailed specifications or manufacturing information, please contact IKO.

Rust Prevention

Black Chrome Surface Treatment

Black chrome surface treatment on the track rail and slide unit improves rust prevention performance.

Fluorine Black Chrome Surface Treatment

A fluorinated resin coating is applied over the black chrome surface treatment to prevent the adherence of foreign substances and to improve rust prevention performance.

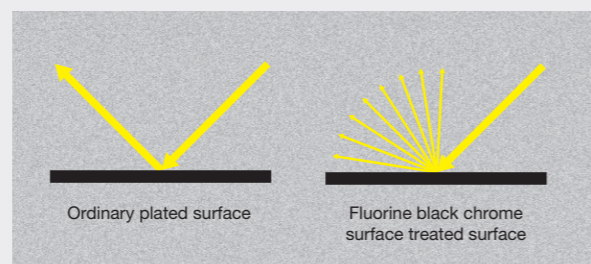
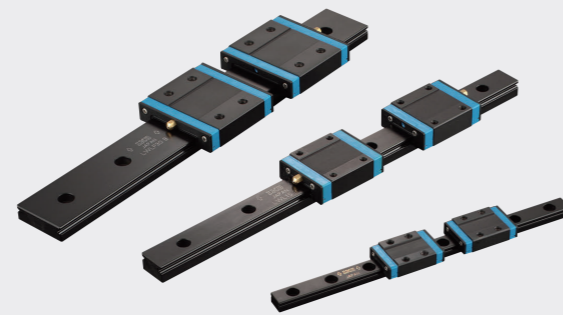

Excellent at diffusing light, it is effective in preventing malfunctions in the optical sensors, etc., currently used for positioning ultra-precision devices.

Corrosion resistance comparison based on humidity cabinet test

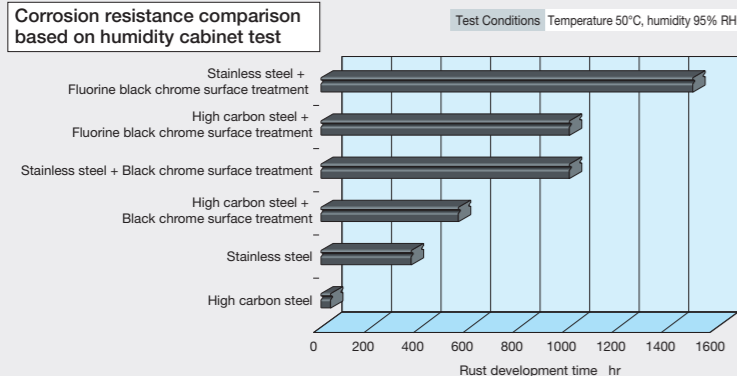

Liquid Crystal Lubricant Series

A new lubricant, neither grease nor oil

Liquid crystal lubricants are completely different from greases composed of base oils and thickeners. They are composed only of liquid crystal compounds, forming a completely new type of lubricant. Conventional grease base oils lubricate using dissimilar molecules, causing difficulties with adhesion to metal surfaces and evaporation. Liquid crystal lubricant forms molecular aggregates, improving adhesion to metal surfaces and minimizing evaporation. The IKO Liquid Crystal Lubricant used in this Series provides excellent lubrication functionality, even under high contact pressure during rolling contact, which results in extremely high performance.

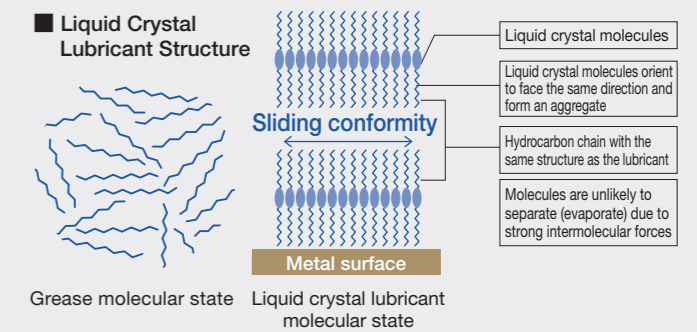

Environmental Benefits

Liquid Crystal Lubricant generates minimal dust and evaporation, making it highly clean. Because it is composed only of carbon, hydrogen and oxygen, it does not contain organic fluorine compounds (PFAS) and supports halogen-free use. In addition, no toxic gases are emitted when burned.

Superior Lubrication Durability

Whether in high-temperature or room-temperature conditions, lubrication durability is far superior to conventional grease. Load durability tests realize a traveling distance six times that of conventional fluorine grease in high temperatures and 70 times at room temperature.

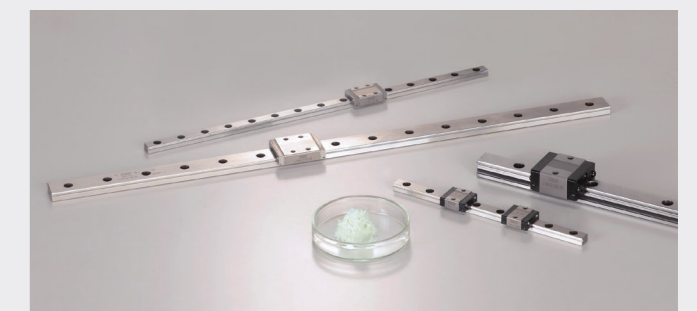

Load Durability (room temperature)

Long-term durability exceeds 70 times that of fluorine grease at room temperature and atmospheric pressure.

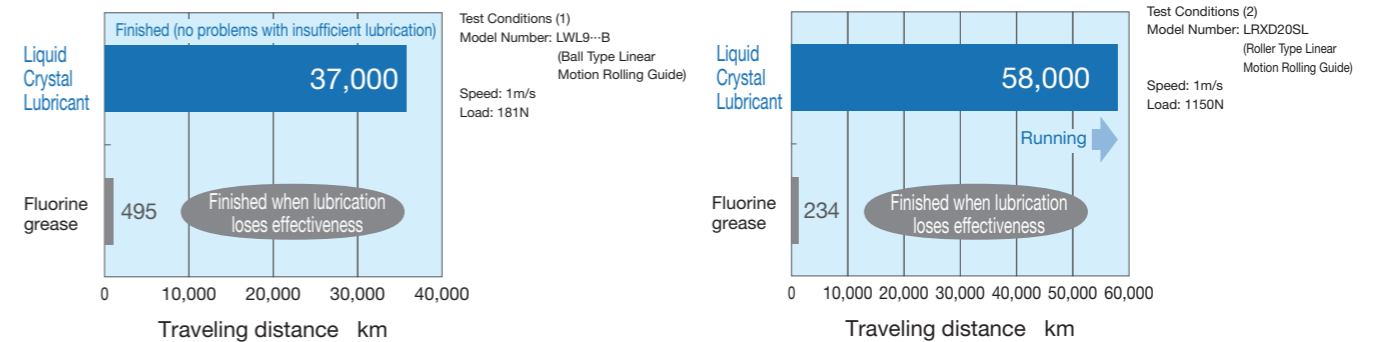

Evaporation Characteristics

There is zero mass loss even at 100°C. Liquid Crystal Lubricants have no loss due to evaporation.

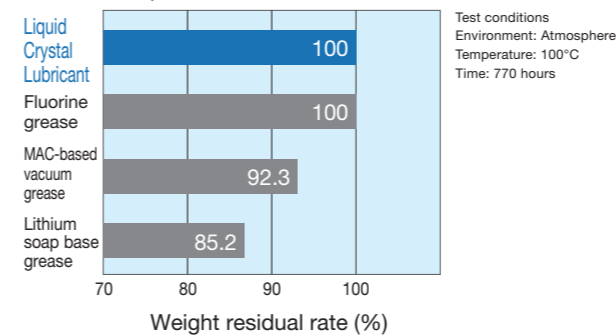

Low Dust-Generation Properties

Dust generation is less than 1/10 of lithium soap-based grease.

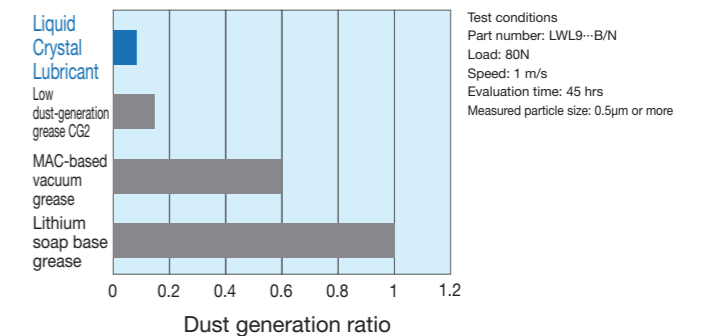

Precautions for Use

- Continuous operating temperature range: 5 to 100°C (maximum operating temperature 120°C)
- The unit must be stored in a dry and clean place with low humidity and unpacked in the same environment before use, as rust prevention oil has not been applied.
- The LCL Linear Way is packed in clean condition, and therefore cleaning or wiping down after removal from the packaging is not necessary.
- Liquid Crystal Lubricant has fluorescent properties under certain ultraviolet light.
- Use gloves when handling so that the Liquid Crystal Lubricant does not touch the skin directly.
- Respective values used in tables are for reference and are not guaranteed values.

Manufacturing Support Model Number¹⁾

- Linear Way L Series²⁾
- Linear Way H Series²⁾
- Linear Roller Way Super X Series²⁾
- Crossed Roller Bearings Series

¹⁾ Liquid Crystal Lubricant Series products are made to order.
²⁾ Applicable for stainless steel models from each series.